

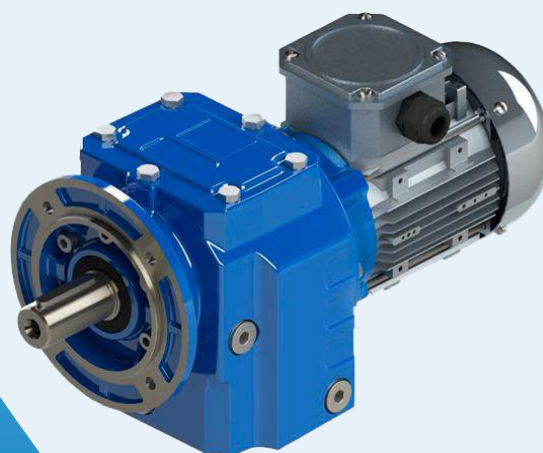

Цилиндрические
соосные редукторы
серии A/F

Таблицы выбора
мотор-редукторов

Габаритные и
присоединительные
размеры

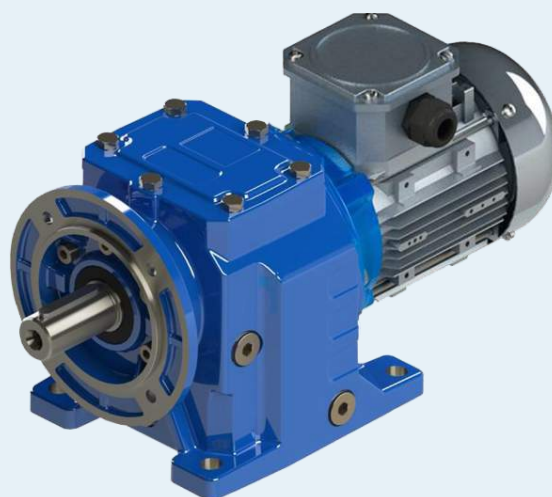
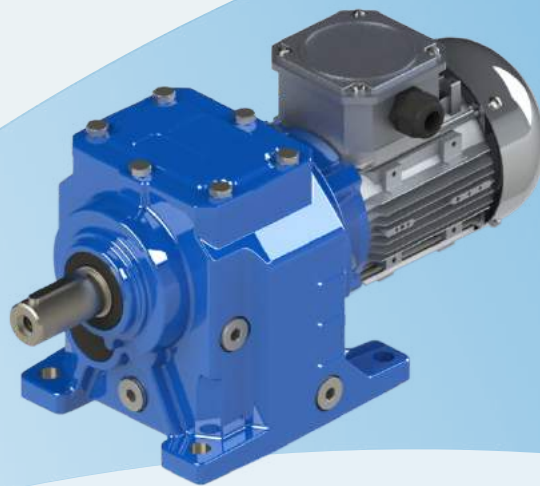

Серия A/F

МОДУЛЬНОСТЬ

A / F...PAM 100

- Модель с возможностью соединении с муфтой двигателя (PAM).

A / F...W

- Модели с входным валом.

A / F...100L/4A

- Модели с небольшим электродвигателем.





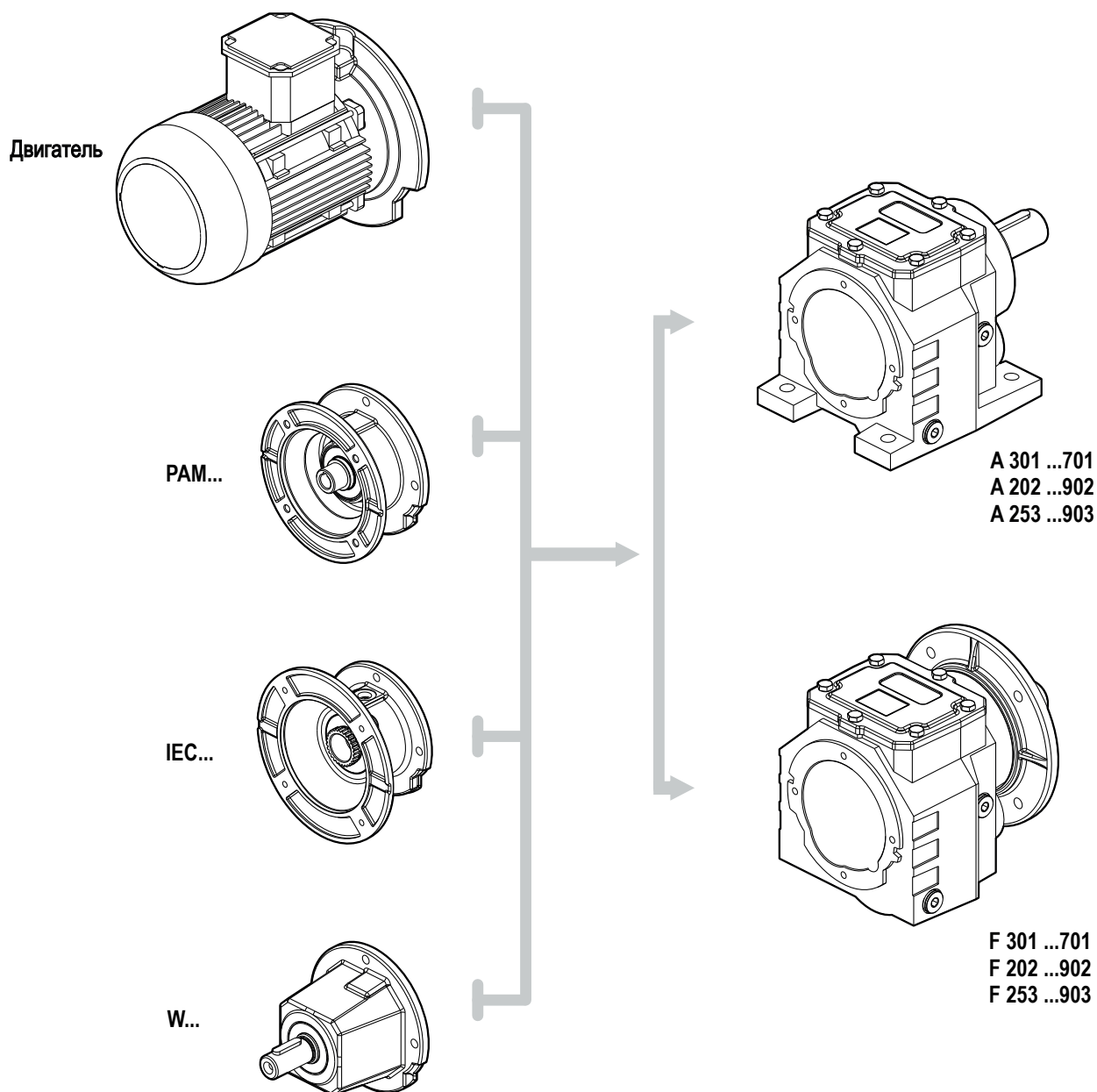

A / F...IEC 100

- Модель с возможностью присоединения к двигателю с упругой муфтой.

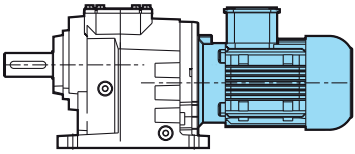
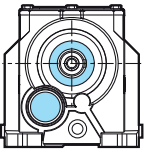
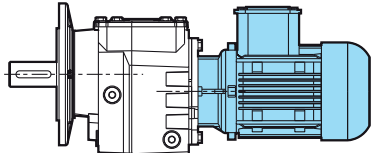
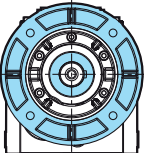
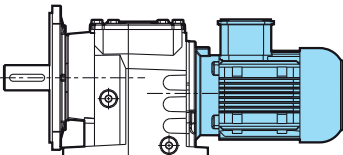

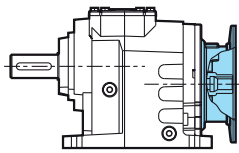
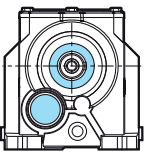
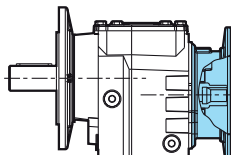
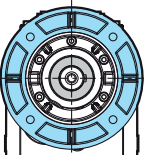
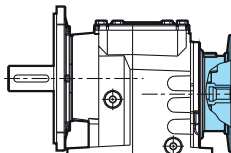
ВАРИАНТЫ ИСПОЛНЕНИЯ И МОНТАЖА

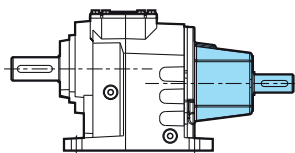
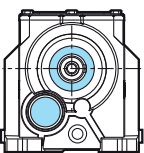
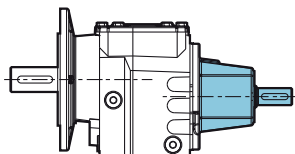
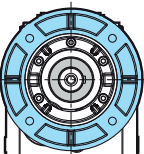
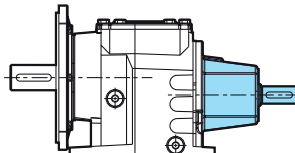
202-202G-252, 253-301, 302, 303-351, 352, 353-401, 402, 403-501, 502, 503-601, 602, 603-701, 702, 703-902, 903

		<p>A... / ДВИГАТЕЛЬ Монтаж на лапах + двигатель</p>
		<p>F... / ДВИГАТЕЛЬ Выходной фланец + двигатель</p>
		<p>AF... / ДВИГАТЕЛЬ Монтаж на лапах и с выходным фланцем + двигатель</p>
		<p>A... / PAM Монтаж на лапах+моторный фланец PAM</p>
		<p>F... / PAM Монтаж с выходным фланцем + моторный фланец PAM</p>
		<p>AF... / PAM Монтаж на лапах и с выходным фланцем + моторный фланец PAM</p>
		<p>A... / W Монтаж на лапах + входной выступающий вал</p>
		<p>F... / W Монтаж с выходным фланцем + входной выступающий вал</p>
		<p>AF... / W Монтаж на лапах и с выходным фланцем + входной выступающий вал</p>

КОДОБРАЗОВАНИЕ

Пример условного обозначения:

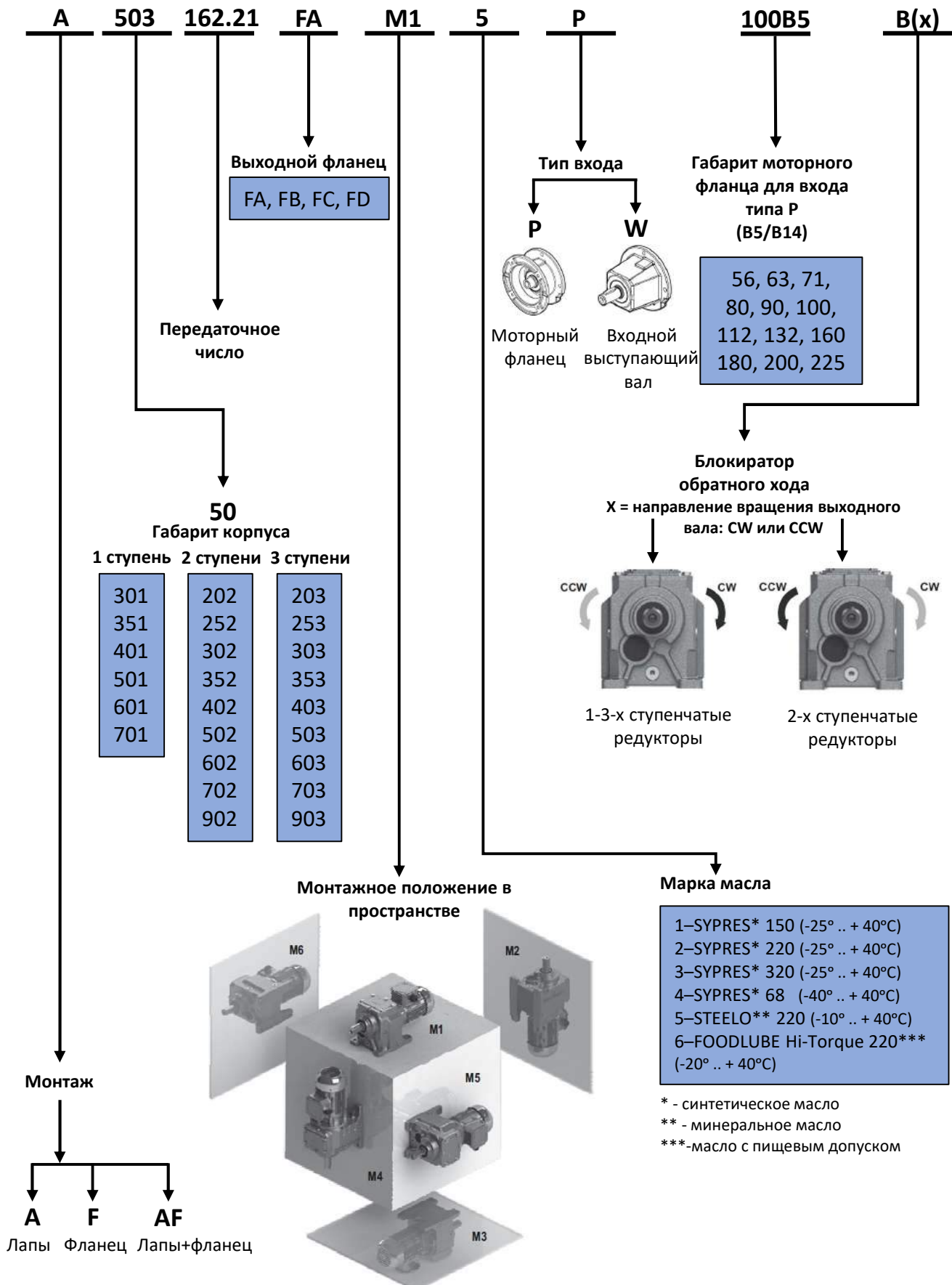

Блокиратор обратного хода

Редуктор может поставляться с блокиратором обратного хода на входном валу. Это устройство обеспечивает вращение выходного вала только в одном направлении. В зависимости от размера, блокиратор обратного хода может быть размещен на фланце входного вала или же на двигателе, такого же размера. В заказе необходимо указать требуемое направление вращения вала. Координаты для связи находятся на сайте [www://reduktor-innovari.ru/](http://reduktor-innovari.ru/).

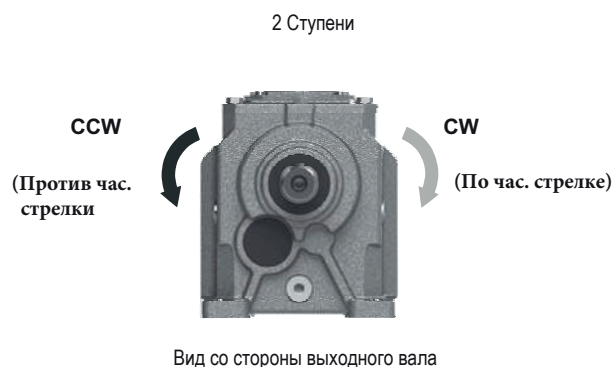

Типоразмеры моторных фланцев с возможностью применения блокиратора обратного хода

Двигатель	063	071	080	090	100 - 112	132	160	180	200	225
Размер	140x11	160x14	200x19	200x24	250x28	300x38	350x42	350x48	400x55	450x60
202	B5/B14	B5/B14								
202 G	B5/B14	B5/B14	B5/B14	B5/B14						
252		B5/B14	B5/B14	B5/B14	B5/B14					
253	B5/B14	B5/B14	B5/B14	B5/B14						
301		B5/B14	B5/B14	B5/B14						
302		B5/B14	B5/B14	B5/B14	B5/B14					
303	B5/B14	B5/B14	B5/B14	B5/B14						
351		B5/B14	B5/B14	B5/B14	B5/B14					
352		B5/B14	B5/B14	B5/B14	B5/B14					
353	B5/B14	B5/B14	B5/B14	B5/B14						
401			B5/B14	B5/B14	B5/B14					
402			B5/B14	B5/B14	B5/B14	B5/B14				
403		B5/B14	B5/B14	B5/B14	B5/B14					
501			B5/B14	B5/B14	B5/B14	B5/B14				
502			B5/B14	B5/B14	B5/B14	B5/B14	B5			
503			B5/B14	B5/B14	B5/B14	B5/B14				
601					B5/B14	B5/B14	B5	B5		
602					B5/B14	B5/B14	B5	B5		
603				B5/B14	B5/B14	B5/B14	B5			
701						B5/B14	B5	B5	B5	
702						B5/B14	B5	B5	B5	
703					B5/B14	B5/B14	B5	B5	B5	
902							B5	B5	B5	B5
903						B5/B14	B5	B5	B5	

ТАБЛИЦЫ ВЫБОРА МОТОР-РЕДУКТОРОВ

Обозначения в таблицах выбора мотор-редуктора и их расшифровка

1.10 кВт → Мощность электродвигателя в кВт

P_1 [кВт]	n_2 [Мин ⁻¹]	M_2 [Нм]	f_B	i	F_{R2} [кН]	Редуктор	K_T	MM
1.10	6.3	1559	1.2	222.59	18.0	A503 - 90S/4A F503 - 90S/4A	60	93
	7.2	1365	1.3	194.86	18.0			
	7.9	1253	1.4	178.98	18.0			
	8.7	1136	1.6	162.21	18.0			
	9.1	1082	1.7	154.52	18.0			
	9.9	994	1.8	142.00	18.0			
	11.3	870	2.1	124.25	18.0			
	12.5	789	2.3	112.61	18.0			
	14.4	685	2.6	97.80	18.0			

↑ Мощность электродвигателя		↑ Сервис-фактор		↑ Передаточное число редуктора				
↓ Обороты на выходном валу редуктора		↓ Крутящий момент на выходе		↓ Допустимая радиальная нагрузка		↓ Тип редуктора ↓ Типоразмер моторного фланца / количество полюсов электродвигателя	↓ Вес редуктора	↓ Страница каталога с чертежами

P_1 [кВт]	n_2 [мин ⁻¹]	M_2 [Нм]	f_B	i	F_R [кН]	Редуктор					
0.09	3.7	221	0.9	245.76	5.5	A253 - 63M/6 F253 - 63M/6	15	77			
	4.6	177	1.1	197.21	5.5						
	5.0	160	1.2	178.56	5.5						
	6.3	129	1.6	143.29	5.5						
	7.3	111	1.8	123.58	5.5						
	8.3	97	2.1	108.02	5.5						
	9.1	89	2.2	99.17	5.5						
	12.0	67	3.0	74.76	5.5						
	13.5	60	3.3	66.56	5.5						
0.12	21.5	53	0.9	63.59	2.5	A202 - 63M/4A F202 - 63M/4A	7	75			
	24.8	46	1.1	55.03	2.5						
	27.8	41	1.1	49.05	2.5						
	32.3	35	1.4	42.20	2.5						
	37.4	31	1.8	36.45	2.5						
	42.1	27	2.0	32.41	2.5						
	49.2	23	2.3	27.75	2.5						
	55.1	21	2.6	24.78	2.5						
	61.3	19	2.9	22.26	2.5						
	63.9	18	3.1	21.36	2.5						
	71.0	16	3.4	19.23	2.5						
	78.6	15	3.8	17.37	2.5						
	86.7	13	4.2	15.75	2.5						
	94.7	12	4.2	14.42	2.5						
	103.2	11	4.2	13.23	2.5						
	118.5	10	5.2	11.52	2.5						
	136.1	8	6.5	10.03	2.5						
	152.9	7	7.3	8.93	2.5						
	170.0	7	8.2	8.03	2.5						
	189.3	6	9.1	7.21	2.5						
	208.4	5	9.6	6.55	2.5						
	228.3	5	11.0	5.98	2.5						
	248.6	5	11.9	5.49	2.5						
	256.1	4	12.3	5.33	2.5						
	285.0	4	13.2	4.79	2.5						
	318.2	4	13.9	4.29	2.5						
	350.0	3	13.7	3.90	2.5						
	383.4	3	16.1	3.56	2.5						
	418.7	3	16.8	3.26	2.5						
	459.6	2	16.9	2.97	2.5						
	482.3	2	16.8	2.83	2.5						
	535.3	2	17.1	2.55	2.5						
	590.9	2	16.8	2.31	2.5						
	643.9	2	16.8	2.12	2.5						
	16.8	68	1.2	81.41	2.8				A 202 G - 63M/4A F 202 G - 63M/4A	9	75
	19.5	59	1.2	70.05	2.8						
	21.9	52	1.2	62.38	2.8						
	25.3	45	1.9	54.05	2.8						
	29.4	39	2.2	46.41	2.8						
	33.0	35	2.4	41.38	2.8						
	35.3	33	2.6	38.72	2.8						
	39.5	29	3.0	34.55	2.8						
	5.6	194	1.0	245.76	5.5				A253 - 63M/4A F253 - 63M/4A	15	77
	6.9	156	1.3	197.21	5.5						
	7.6	141	1.4	178.56	5.5						
9.5	113	1.8	143.29	5.5							
11.0	98	2.1	123.58	5.5							
12.6	85	2.3	108.02	5.5							
13.8	78	2.6	99.17	5.5							
18.3	59	3.4	74.76	5.5							
20.5	53	3.8	66.56	5.5							
4.8	222	0.9	178.56	5.5	A253 - 63M/6B F253 - 63M/6B	15	77				
6.0	178	1.1	143.29	5.5							
7.0	154	1.3	123.58	5.5							
8.0	135	1.5	108.02	5.5							
8.7	124	1.6	99.17	5.5							
11.6	93	2.1	74.76	5.5							
13.0	83	2.4	66.56	5.5							
16.2	67	3.0	53.41	5.5							



0.12 kW
0.15 kW
0.18 kW







P_1 [кВт]	n_2 [мин ⁻¹]	M_2 [Нм]	f_B	i	F_R [кН]	Редуктор	K_T	MM
0.12	4.8	223	1.3	282.17	6.6	A303 - 63M/4A F303 - 63M/4A	18	81
	6.0	180	1.7	227.56	6.6			
	6.7	162	1.9	205.01	6.6			
	8.3	130	2.3	165.33	6.6			
	9.6	112	2.7	141.89	6.6			
	10.9	99	3.0	125.65	6.6			
	11.9	90	3.3	114.42	6.6			
	3.1	351	0.9	282.17	6.6	A303 - 63M/6B F303 - 63M/6B	18	81
	3.8	283	1.1	227.56	6.6			
	4.2	255	1.2	205.01	6.6			
	5.2	206	1.5	165.33	6.6			
	6.1	177	1.7	141.89	6.6			
	6.9	156	1.9	125.65	6.6			
	7.6	142	2.1	114.42	6.6			
	9.9	108	2.8	86.96	6.6	A353 - 63M/4A F353 - 63M/4A	23	85
	6.3	171	2.9	216.67	8.0			
	7.0	154	3.3	194.72	8.0			
	3.2	334	1.5	268.00	8.0	A353 - 63M/6B F353 - 63M/6B	23	85
	4.0	270	1.9	216.67	8.0			
	4.4	242	2.1	194.72	8.0			
	5.5	196	2.6	157.42	8.0			
	6.4	168	3.0	134.76	8.0			
	7.9	136	3.7	108.95	8.0			
	6.3	214	0.9	143.29	5.5			
	7.3	185	1.1	123.58	5.5			
	8.3	162	1.2	108.02	5.5			
	9.1	148	1.3	99.17	5.5			
	12.0	112	1.8	74.76	5.5			
13.5	100	2.0	66.56	5.5				
16.9	80	2.5	53.41	5.5				
4.0	340	0.9	227.56	6.6	A 303 - 63M/6C F 303 - 63M/6C	18	81	
4.4	307	1.0	205.01	6.6				
5.4	247	1.2	165.33	6.6				
6.3	212	1.4	141.89	6.6				
7.2	188	1.6	125.65	6.6				
7.9	171	1.8	114.42	6.6				
10.3	130	2.3	86.96	6.6				
11.8	114	2.6	76.42	6.6	A 353 - 63M/6C F 353 - 63M/6C	23	83	
14.6	92	3.3	61.63	6.6				
3.4	401	1.2	268.00	8.0				
4.2	324	1.5	216.67	8.0				
4.6	291	1.7	194.72	8.0				
5.7	236	2.1	157.42	8.0				
6.7	202	2.5	134.76	8.0				
8.3	163	3.1	108.95	8.0				
9.9	135	3.7	90.51	8.0				
0.18	32.7	53	1.0	42.20	2.5	A202 - 63M/4B F202 - 63M/4B	8	73
	37.9	45	1.2	36.45	2.5			
	42.6	40	1.4	32.41	2.5			
	49.7	35	1.6	27.75	2.5			
	55.7	31	1.8	24.78	2.5			
	62.0	28	2.0	22.26	2.5			
	64.6	27	2.1	21.36	2.5			
	71.8	24	2.3	19.23	2.5			
	79.4	22	2.5	17.37	2.5			
	87.6	20	2.8	15.75	2.5			
	95.7	18	2.8	14.42	2.5			
	104.3	16	2.9	13.23	2.5			
	119.8	14	3.5	11.52	2.5			
	137.6	12	4.4	10.03	2.5			
	154.5	11	4.9	8.93	2.5			
	171.9	10	5.5	8.03	2.5			
	191.4	9	6.1	7.21	2.5			
	210.7	8	6.5	6.55	2.5			
	230.8	7	7.4	5.98	2.5			
	251.4	7	8.0	5.49	2.5			



P_1 [кВт]	n_2 [мин ⁻¹]	M_2 [Нм]	f_B	i	F_R [кН]	Редуктор		
0.18	258.9	7	8.3	5.33	2.5	A202 - 63M/4B F202 - 63M/4B	8	73
	288.1	6	8.9	4.79	2.5			
	321.7	5	9.4	4.29	2.5			
	353.8	5	9.3	3.90	2.5			
	387.6	4	10.8	3.56	2.5			
	423.3	4	11.2	3.26	2.5			
	464.6	4	11.4	2.97	2.5			
	487.6	4	11.2	2.83	2.5			
	541.2	3	11.6	2.55	2.5			
	597.4	3	11.3	2.31	2.5			
650.9	3	11.4	2.12	2.5				
	17.0	101	0.8	81.41	2.8	A 202 G - 63M/4B F 202 G - 63M/4B	9	75
	19.7	87	0.8	70.05	2.8			
	22.1	78	0.8	62.38	2.8			
	25.5	67	1.3	54.05	2.8			
	29.7	58	1.5	46.41	2.8			
	33.3	52	1.6	41.38	2.8			
	35.6	48	1.8	38.72	2.8			
	39.9	43	2.0	34.55	2.8			
	44.5	39	2.4	31.03	2.8			
	49.9	34	2.7	27.66	2.8			
55.6	31	3.0	24.83	2.8				
	18.8	88	2.3	47.93	5.5	A252 - 71M/6A F252 - 71M/6A	19	77
	21.4	77	2.6	42.00	5.5			
	23.4	71	2.8	38.46	5.5			
	27.0	61	3.3	33.38	5.5			
	29.9	55	3.6	30.15	5.5			
	11.4	142	1.1	245.76	5.5	A253 - 63M/2A F253 - 63M/2A	15	77
	14.2	114	1.4	197.21	5.5			
	15.7	103	1.5	178.56	5.5			
	19.5	83	1.9	143.29	5.5			
	22.7	71	2.2	123.58	5.5			
	25.9	62	2.5	108.02	5.5			
	28.2	57	2.7	99.17	5.5			
	37.5	43	3.6	74.76	5.5			
	7.7	209	1.0	178.56	5.5	A253 - 63M/4B F253 - 63M/4B	15	77
	9.6	168	1.2	143.29	5.5			
	11.2	145	1.4	123.58	5.5			
	12.8	126	1.6	108.02	5.5			
	13.9	116	1.7	99.17	5.5			
	18.5	88	2.3	74.76	5.5			
	20.7	78	2.6	66.56	5.5			
	25.8	63	3.2	53.41	5.5			
	7.3	222	0.9	123.58	5.5	A253 - 71M/6A F253 - 71M/6A	19	77
	8.3	194	1.0	108.02	5.5			
	9.1	178	1.1	99.17	5.5			
	12.0	134	1.5	74.76	5.5			
	13.5	120	1.7	66.56	5.5			
	16.9	96	2.1	53.41	5.5			
	101.4	16	3.3	8.88	1.0	A301 - 71M/6A F301 - 71M/6A	18	79
	115.7	14	3.5	7.78	1.0			
	16.4	101	2.8	55.03	6.6	A302 - 71M/6A F302 - 71M/6A	22	81
	18.7	88	3.2	48.22	6.6			
	20.3	81	3.4	44.38	6.6			
	9.9	163	1.4	282.17	6.6	A303 - 63M/2A F303 - 63M/2A	18	81
	12.3	131	1.7	227.56	6.6			
	13.7	118	1.9	205.01	6.6			
	16.9	95	2.4	165.33	6.6			
	19.7	82	2.7	141.89	6.6			
	22.3	73	3.1	125.65	6.6			
	24.5	66	3.4	114.42	6.6			

P_1 [кВт]	n_2 [мин ⁻¹]	M_2 [Нм]	f_B	i	F_R [кН]	Редуктор		
0.18	4.9	330	0.9	282.17	6.6	A303 - 63M/4B F303 - 63M/4B	18	81
	6.1	266	1.1	227.56	6.6			
	6.7	240	1.2	205.01	6.6			
	8.3	194	1.5	165.33	6.6			
	9.7	166	1.8	141.89	6.6			
	11.0	147	2.0	125.65	6.6			
	12.1	134	2.2	114.42	6.6			
	15.9	102	2.9	86.96	6.6			
	18.1	89	3.4	76.42	6.6			
	5.4	297	1.0	165.33	6.6			
	6.3	255	1.2	141.89	6.6			
	7.2	226	1.3	125.65	6.6			
	7.9	205	1.5	114.42	6.6			
	10.3	156	1.9	86.96	6.6			
	11.8	137	2.2	76.42	6.6			
	14.6	111	2.7	61.63	6.6			
	10.4	155	2.4	268.00	8.0	A353 - 63M/2A F353 - 63M/2A	23	83
	12.9	125	3.0	216.67	8.0			
	14.4	112	3.3	194.72	8.0			
	5.1	314	1.6	268.00	8.0	A353 - 63M/4B F353 - 63M/4B	23	83
	6.4	254	2.0	216.67	8.0			
	7.1	228	2.2	194.72	8.0			
	8.8	184	2.7	157.42	8.0			
	10.2	158	3.2	134.76	8.0			
	12.7	128	3.9	108.95	8.0			
	3.4	481	1.0	268.00	8.0	A353 - 71M/6A F353 - 71M/6A	27	83
	4.2	389	1.3	216.67	8.0			
	4.6	350	1.4	194.72	8.0			
5.7	283	1.8	157.42	8.0				
6.7	242	2.1	134.76	8.0				
8.3	196	2.6	108.95	8.0				
9.9	163	3.1	90.51	8.0				
12.4	130	3.8	72.58	8.0				
3.4	481	1.8	267.75	12.0	A 403 - 71M/6A F 403 - 71M/6A			
3.8	421	2.0	234.50	12.0				
4.2	386	2.2	215.01	12.0				
4.8	334	2.5	186.14	12.0				
5.3	306	2.8	170.55	12.0				
6.0	268	3.2	149.47	12.0				
6.6	243	3.5	135.37	12.0				
0.22	9.8	202	1.0	143.29	5.5	A253 - 63M/4D F253 - 63M/4D	16	77
	11.3	174	1.1	123.58	5.5			
	13.0	152	1.3	108.02	5.5			
	14.1	140	1.4	99.17	5.5			
	18.7	105	1.9	74.76	5.5			
	21.0	94	2.1	66.56	5.5			
	26.2	75	2.7	53.41	5.5			
	6.2	321	0.9	227.56	6.6			
	6.8	289	1.0	205.01	6.6			
	8.5	233	1.3	165.33	6.6			
	9.9	200	1.5	141.89	6.6			
	11.1	177	1.7	125.65	6.6			
	12.2	161	1.9	114.42	6.6			
	16.1	123	2.4	86.96	6.6			
	18.3	108	2.8	76.42	6.6			
	22.7	87	3.5	61.63	6.6			
	5.2	378	1.3	268.00	8.0	A353 - 63M/4D F353 - 63M/4D	24	83
	6.5	306	1.6	216.67	8.0			
	7.2	275	1.8	194.72	8.0			
	8.9	222	2.3	157.42	8.0			
10.4	190	2.6	134.76	8.0				
12.8	154	3.3	108.95	8.0				
15.5	128	3.9	90.51	8.0				



P_1 [кВт]	n_2 [мин ⁻¹]	M_2 [Нм]	f_B	i	F_R [кН]	Редуктор		
0.25	260.8	9	6.0	5.33	2.5	A202 - 71M/4A F202 - 71M/4A	8	73
	290.2	8	6.4	4.79	2.5			
	324.0	7	6.8	4.29	2.5			
	356.4	7	6.7	3.90	2.5			
	390.4	6	7.8	3.56	2.5			
	426.4	6	8.2	3.26	2.5			
	468.0	5	8.2	2.97	2.5			
	491.2	5	8.2	2.83	2.5			
	545.1	4	8.3	2.55	2.5			
	601.7	4	8.2	2.31	2.5			
655.7	4	8.2	2.12	2.5				
	50.1	48	1.1	27.75	2.5	A202 - 71M/4A F202 - 71M/4A	8	73
	56.1	43	1.3	24.78	2.5			
	62.4	38	1.4	22.26	2.5			
	65.1	37	1.5	21.36	2.5			
	72.3	33	1.7	19.23	2.5			
	80.0	30	1.8	17.37	2.5			
	88.3	27	2.0	15.75	2.5			
	96.4	25	2.1	14.42	2.5			
	105.1	23	2.1	13.23	2.5			
	120.7	20	2.5	11.52	2.5			
	138.6	17	3.2	10.03	2.5			
	155.7	15	3.6	8.93	2.5			
	173.1	14	4.0	8.03	2.5			
	192.8	12	4.4	7.21	2.5			
	212.2	11	4.7	6.55	2.5			
	232.4	10	5.4	5.98	2.5			
253.2	9	5.8	5.49	2.5				
	25.7	93	0.9	54.05	2.8	A 202 G - 71M/4A F 202 G - 71M/4A	11	75
	30.0	80	1.1	46.41	2.8			
	33.6	71	1.2	41.38	2.8			
	35.9	67	1.3	38.72	2.8			
	40.2	59	1.4	34.55	2.8			
	44.8	53	1.7	31.03	2.8			
	50.3	48	1.9	27.66	2.8			
	56.0	43	2.2	24.83	2.8			
	61.9	39	2.4	22.44	2.8			
	68.3	35	2.4	20.35	2.8			
	74.6	32	2.6	18.63	2.8			
		29.0	79	2.5	47.93			
33.1		69	2.9	42.00	5.5			
36.1		63	3.2	38.46	5.5			
41.6		55	3.6	33.38	5.5			
	19.0	121	1.7	47.93	5.5	A252 - 71M/6B F252 - 71M/6B	23	77
	21.7	106	1.9	42.00	5.5			
	23.7	97	2.1	38.46	5.5			
	27.3	84	2.4	33.38	5.5			
	30.2	76	2.6	30.15	5.5			
	34.0	67	3.0	26.79	5.5			
	37.6	61	3.3	24.19	5.5			
	39.5	58	3.4	23.04	5.5			
	15.7	143	1.1	178.56	5.5	A253 - 63M/2B F253 - 63M/2B	16	77
	19.5	115	1.4	143.29	5.5			
	22.7	99	1.6	123.58	5.5			
	25.9	87	1.8	108.02	5.5			
	28.2	79	2.0	99.17	5.5			
	37.5	60	2.6	74.76	5.5			
	42.1	53	2.9	66.56	5.5			
52.4	43	3.6	53.41	5.5				
	11.2	200	1.0	123.58	5.5	A/F 253 - 63M/4C A/F 253 - 71M/4A	18	77
	12.9	174	1.1	108.02	5.5			
	14.0	160	1.2	99.17	5.5			
	18.6	121	1.7	74.76	5.5			
	20.9	107	1.9	66.56	5.5			
	26.0	86	2.3	53.41	5.5			

P_1 [кВт]	n_2 [мин ⁻¹]	M_2 [Нм]	f_B	i	F_R [кН]	Редуктор				
0.25	12.2	184	1.1	74.76	5.5	A253 - 71M/6B F253 - 71M/6B	23	77		
	13.7	164	1.2	66.56	5.5					
	17.0	132	1.5	53.41	5.5					
	156.6	15	3.7	8.88	1.0	A301 - 71M/4A F301 - 71M/4A	14	79		
	178.7	13	3.9	7.78	1.0					
	102.5	23	2.4	8.88	1.0	A301 - 71M/6B F301 - 71M/6B	19	79		
	117.0	20	2.5	7.78	1.0					
	147.2	16	3.2	6.18	1.0					
	163.0	14	3.5	5.58	1.0					
	179.2	13	3.5	5.08	1.0					
	25.3	91	3.1	55.03	6.6	A302 - 71M/4A F302 - 71M/4A	21	81		
	28.8	80	3.5	48.22	6.6					
	31.3	73	3.8	44.38	6.6					
	16.5	139	2.0	55.03	6.6	A302 - 71M/6B F302 - 71M/6B	26	81		
	18.9	121	2.3	48.22	6.6					
	20.5	112	2.5	44.38	6.6					
	23.7	97	2.9	38.33	6.6					
	26.3	87	3.2	34.62	6.6					
	29.4	78	3.6	30.91	6.6					
	9.9	226	1.0	282.17	6.6					
12.3	182	1.3	227.56	6.6	A303 - 63M/2B F303 - 63M/2B	19	81			
13.7	164	1.4	205.01	6.6						
16.9	133	1.7	165.33	6.6						
19.7	114	2.0	141.89	6.6						
22.3	101	2.3	125.65	6.6						
24.5	92	2.5	114.42	6.6						
32.2	70	3.3	86.96	6.6						
36.6	61	3.8	76.42	6.6						
6.8	331	0.9	205.01	6.6				A/F 303 - 63M/4C A/F 303 - 71M/4A	21	81
8.4	267	1.1	165.33	6.6						
9.8	229	1.3	141.89	6.6						
11.1	203	1.5	125.65	6.6						
12.1	185	1.6	114.42	6.6						
16.0	140	2.1	86.96	6.6						
18.2	123	2.4	76.42	6.6						
22.6	100	3.0	61.63	6.6						
7.2	310	1.0	125.65	6.6	A303 - 71M/6B F303 - 71M/6B	26	81			
8.0	282	1.1	114.42	6.6						
10.5	214	1.4	86.96	6.6						
11.9	188	1.6	76.42	6.6						
14.8	152	2.0	61.63	6.6						
16.0	143	3.4	56.95	8.0	A352 - 71M/6B F352 - 71M/6B	31	85			
10.4	215	1.8	268.00	8.0	A353 - 63M/2B F353 - 63M/2B	24	85			
12.9	174	2.2	216.67	8.0						
14.4	156	2.5	194.72	8.0						
17.8	126	3.1	157.42	8.0						
20.8	108	3.6	134.76	8.0						
5.2	433	1.2	268.00	8.0	A/F 353 - 63M/4C A/F 353 - 71M/4A	26	85			
6.4	350	1.4	216.67	8.0						
7.1	314	1.6	194.72	8.0						
8.8	254	2.0	157.42	8.0						
10.3	218	2.3	134.76	8.0						
12.8	176	2.8	108.95	8.0						
15.4	146	3.4	90.51	8.0						
4.2	534	0.9	216.67	8.0	A353 - 71M/6B F353 - 71M/6B	31	85			
4.7	480	1.0	194.72	8.0						
5.8	388	1.3	157.42	8.0						
6.8	332	1.5	134.76	8.0						
8.4	269	1.9	108.95	8.0						
10.1	223	2.2	90.51	8.0						
12.5	179	2.8	72.58	8.0						
15.5	145	3.5	58.68	8.0						



P_1 [кВт]	n_2 [мин ⁻¹]	M_2 [Нм]	f_B	i	F_R [кН]	Редуктор		
0.25	5.2	432	2.0	267.75	12.0	A403 - 71M/4A F403 - 71M/4A	36	89
	5.9	379	2.2	234.50	12.0			
	6.5	347	2.4	215.01	12.0			
	7.5	301	2.8	186.14	12.0			
	8.2	275	3.1	170.55	12.0			
	9.3	241	3.5	149.47	12.0			
	10.3	219	3.9	135.37	12.0			
	3.4	660	1.3	267.75	12.0	A403 - 71M/6B F403 - 71M/6B	41	89
	3.9	578	1.5	234.50	12.0			
	4.2	530	1.6	215.01	12.0			
	4.9	459	1.9	186.14	12.0			
	5.3	421	2.0	170.55	12.0			
	6.1	369	2.3	149.47	12.0			
	6.7	334	2.5	135.37	12.0			
7.7	291	2.9	118.13	12.0				
9.6	234	3.6	94.86	12.0				
0.37	50.1	71	0.8	27.75	2.5	A202 - 71M/4B F202 - 71M/4B	9	73
	56.1	63	0.9	24.78	2.5			
	62.4	57	1.0	22.26	2.5			
	65.1	54	1.0	21.36	2.5			
	72.3	49	1.1	19.23	2.5			
	80.0	44	1.2	17.37	2.5			
	88.3	40	1.4	15.75	2.5			
	96.4	37	1.4	14.42	2.5			
	105.1	34	1.4	13.23	2.5			
	120.7	29	1.7	11.52	2.5			
	138.6	25	2.2	10.03	2.5			
	155.7	23	2.4	8.93	2.5			
	173.1	20	2.7	8.03	2.5			
	192.8	18	3.0	7.21	2.5			
	212.2	17	3.2	6.55	2.5			
	232.4	15	3.6	5.98	2.5			
	253.2	14	3.9	5.49	2.5			
	260.8	14	4.1	5.33	2.5			
	290.2	12	4.4	4.79	2.5			
	324.0	11	4.6	4.29	2.5			
	356.4	10	4.5	3.90	2.5			
	390.4	9	5.3	3.56	2.5			
	426.4	8	5.6	3.26	2.5			
	468.0	8	5.6	2.97	2.5			
	491.2	7	5.6	2.83	2.5			
	545.1	6	5.7	2.55	2.5			
	601.7	6	5.6	2.31	2.5			
	655.7	5	5.6	2.12	2.5			
	35.9	98	0.9	38.72	2.8	A 202 G - 71M/4B F 202 G - 71M/4B	11	75
	40.2	88	1.0	34.55	2.8			
	44.8	79	1.2	31.03	2.8			
	50.3	70	1.3	27.66	2.8			
	56.0	63	1.5	24.83	2.8			
	61.9	57	1.6	22.44	2.8			
	68.3	52	1.6	20.35	2.8			
	74.6	47	1.8	18.63	2.8			
	88.3	40	2.1	15.74	2.8			
	102.5	34	2.5	13.56	2.8			
	115.0	31	2.8	12.09	2.8			
	121.8	29	2.9	11.41	2.8			
	128.1	28	3.1	10.85	2.8			
	58.4	56	2.7	47.93	5.5	A252 - 71M/2A F252 - 71M/2A	18	77
	66.7	51	2.9	42.00	5.5			
	72.8	47	3.2	38.46	5.5			
83.9	40	3.7	33.38	5.5				
29.0	117	1.7	47.93	5.5	A252 - 71M/4B F252 - 71M/4B	20	77	
33.1	102	2.0	42.00	5.5				
36.1	94	2.1	38.46	5.5				
41.6	81	2.5	33.38	5.5				
46.1	74	2.7	30.15	5.5				
51.9	65	3.1	26.79	5.5				
57.5	59	3.4	24.19	5.5				
60.3	56	3.6	23.04	5.5				

P_1 [кВт]	n_2 [мин ⁻¹]	M_2 [Нм]	f_B	i	F_R [кН]	Редуктор					
0.37	19.2	177	1.1	47.93	5.5	A/F 252 - 71M/6 A/F 252 - 80M/6A	21	77			
	21.9	155	1.3	42.00	5.5						
	23.9	142	1.4	38.46	5.5						
	27.6	123	1.6	33.38	5.5						
	30.5	111	1.8	30.15	5.3						
	34.3	99	2.0	26.79	5.0						
	38.0	89	2.2	24.19	4.8						
	39.9	85	2.4	23.04	4.7						
	45.6	74	2.7	20.19	4.4						
	49.8	68	2.9	18.49	4.2						
	54.0	63	3.0	17.05	4.1						
	61.7	55	3.1	14.91	4.1						
	66.0	51	3.3	13.94	3.9						
	76.9	44	3.3	11.97	3.9						
	89.1	38	3.7	10.32	3.7						
	22.7	147	1.1	123.58	5.5				A/F 253 - 63M/2D A/F 253 - 71M/2A	18	77
	25.9	128	1.2	108.02	5.5						
	28.2	118	1.3	99.17	5.5						
37.5	89	1.8	74.76	5.5							
42.1	79	2.0	66.56	5.5							
52.4	63	2.5	53.41	5.5							
18.6	179	1.1	74.76	5.5	A253 - 71M/4B F253 - 71M/4B	20	77				
20.9	159	1.3	66.56	5.5							
26.0	128	1.6	53.41	5.5							
17.2	193	1.0	53.41	5.5	A/F 253 - 71M/6 A/F 253 - 80M/6A	21	77				
315.7	11	3.9	8.87	1.0	A301 - 71M/2A F301 - 71M/2A	14	79				
156.7	22	2.5	8.87	1.0	A301 - 71M/4B F301 - 71M/4B	17	79				
178.7	19	2.6	7.78	1.0							
224.9	15	3.3	6.18	1.0							
249.0	14	3.6	5.58	1.0							
273.8	13	3.6	5.08	1.0							
103.7	33	1.7	8.87	1.0				A301 - 80M/6A F301 - 80M/6A	17	79	
118.3	29	1.7	7.78	1.0							
148.9	23	2.2	6.18	1.0							
164.8	21	2.4	5.58	1.0							
181.2	19	2.4	5.08	1.0							
215.6	16	2.8	4.27	1.0							
252.3	14	3.3	3.65	1.0							
291.3	12	3.4	3.16	1.0							
333.1	10	2.9	2.76	1.0							
355.1	10	3.1	2.59	1.0							
451.3	8	3.3	2.04	0.9							
50.9	63	3.4	55.03	6.6	A302 - 71M/2A F302 - 71M/2A	21	81				
58.1	55	3.8	48.22	6.6							
25.3	134	2.1	55.03	6.6	A302 - 71M/4B F302 - 71M/4B	24	81				
28.8	118	2.4	48.22	6.6							
31.3	108	2.6	44.38	6.6							
36.3	94	3.0	38.33	6.6							
40.2	84	3.3	34.62	6.6							
45.0	75	3.7	30.91	6.6							
16.7	203	1.4	55.03	6.6	A/F 302 - 71M/6 A/F 302 - 80M/6A	24	81				
19.1	178	1.6	48.22	6.6							
20.7	164	1.7	44.38	6.6							
24.0	141	2.0	38.33	6.6							
26.6	128	2.2	34.62	6.6							
29.8	114	2.5	30.91	6.6							
33.0	103	2.7	27.92	6.6							
34.8	98	2.7	26.45	6.6							
39.2	87	3.0	23.49	6.3							
43.1	79	3.2	21.33	6.1							
47.7	71	3.5	19.29	5.8							



P_1 [кВт]	n_2 [мин ⁻¹]	M_2 [Нм]	f_B	i	F_R [кН]	Редуктор		
0.37	16.9	188	1.2	165.33	6.6	A/F 303 - 63M/2D A/F 303 - 71M/2A	21	81
	19.7	161	1.4	141.89	6.6			
	22.3	143	1.6	125.65	6.6			
	24.5	130	1.7	114.42	6.6			
	32.2	99	2.3	86.96	6.6			
	36.6	87	2.6	76.42	6.6			
	45.4	70	3.2	61.63	6.6			
	11.1	300	1.0	125.65	6.6	A303 - 71M/4B F303 - 71M/4B	23	81
	12.1	273	1.1	114.42	6.6			
	16.0	208	1.4	86.96	6.6			
	18.2	183	1.6	76.42	6.6			
	22.6	147	2.0	61.63	6.6			
	10.6	314	1.0	86.96	6.6	A/F 303 - 71M/6 A/F 303 - 80M/6A	24	81
	12.0	276	1.1	76.42	6.6			
	14.9	223	1.3	61.63	6.6			
	109.8	31	3.2	8.38	2.5	A/F 351 - 71M/6 A/F 351 - 80M/6A	18	83
	125.5	27	3.7	7.33	2.5			
	24.4	139	3.5	56.95	8.0	A352 - 71M/4B F352 - 71M/4B	28	85
	16.2	210	2.3	56.95	8.0	A/F 352 - 71M/6 A/F 352 - 80M/6A	29	85
	18.4	184	2.7	49.88	8.0			
	20.0	170	2.9	46.04	8.0			
	23.2	146	3.4	39.59	8.0			
	10.4	304	1.2	268.00	8.0	A/F 353 - 63M/2D A/F 353 - 71M/2A	26	85
	12.9	246	1.5	216.67	8.0			
	14.4	221	1.7	194.72	8.0			
	17.8	179	2.1	157.42	8.0			
	20.8	153	2.5	134.76	8.0			
	25.7	124	3.0	108.95	8.0			
	30.9	103	3.6	90.51	8.0			
	6.4	518	1.0	216.67	8.0	A353 - 71M/4B F353 - 71M/4B	28	85
	7.1	465	1.1	194.72	8.0			
	8.8	376	1.3	157.42	8.0			
	10.3	322	1.6	134.76	8.0			
	12.8	260	1.9	108.95	8.0			
	15.4	216	2.3	90.51	8.0			
	19.2	173	2.9	72.58	8.0			
	23.7	140	3.6	58.68	8.0			
	6.8	487	1.0	134.76	8.0			
	8.4	393	1.3	108.95	8.0			
	10.2	327	1.5	90.51	8.0			
	12.7	262	1.9	72.58	8.0			
	15.7	212	2.4	58.68	8.0			
10.4	306	2.1	267.75	12.0	A403 - 71M/2A F403 - 71M/2A	36	89	
11.9	266	2.4	234.50	12.0				
13.0	244	2.6	215.01	12.0				
15.0	211	3.0	186.14	12.0				
16.4	194	3.3	170.55	12.0				
18.7	170	3.8	149.47	12.0				
5.2	640	1.3	267.75	12.0	A403 - 71M/4B F403 - 71M/4B	38	89	
5.9	560	1.5	234.50	12.0				
6.5	514	1.7	215.01	12.0				
7.5	445	1.9	186.14	12.0				
8.2	408	2.1	170.55	12.0				
9.3	357	2.4	149.47	12.0				
10.3	323	2.6	135.37	12.0				
11.8	282	3.0	118.13	12.0				
14.7	227	3.7	94.86	12.0				



P_1 [кВт]	n_2 [мин ⁻¹]	M_2 [Нм]	f_B	i	F_R [кН]	Редуктор		
0.37	3.9	847	1.0	234.50	12.0	A/F 403 - 71M/6 A/F 403 - 80M/6A	40	89
	4.3	776	1.1	215.01	12.0			
	4.9	672	1.3	186.14	12.0			
	5.4	616	1.4	170.55	12.0			
	6.2	540	1.6	149.47	12.0			
	6.8	489	1.7	135.37	12.0			
	7.8	426	2.0	118.13	12.0			
	9.7	342	2.5	94.86	12.0			
	10.7	310	2.7	85.91	12.0			
	4.1	804	2.2	222.59	18.0			
	4.7	704	2.6	194.86	18.0			
	5.1	646	2.8	178.98	18.0			
	5.7	586	3.1	162.21	18.0			
	6.0	558	3.2	154.52	18.0			
6.5	513	3.5	142.00	18.0				
0.55	80.6	65	0.8	17.37	2.5	A202 - 71M/4C F202 - 71M/4C	10	73
	88.9	59	0.9	15.75	2.5			
	97.1	54	0.9	14.42	2.5			
	105.8	50	0.9	13.23	2.5			
	121.5	43	1.2	11.52	2.5			
	139.6	38	1.5	10.03	2.5			
	156.8	34	1.6	8.93	2.5			
	174.3	30	1.8	8.03	2.5			
	194.2	27	2.0	7.21	2.5			
	213.7	25	2.2	6.55	2.5			
	234.1	22	2.5	5.98	2.5			
	255.0	21	2.7	5.49	2.5			
	262.7	20	2.8	5.33	2.5			
	292.3	18	2.9	4.79	2.5			
	326.3	16	3.1	4.29	2.5			
	359.0	15	3.1	3.90	2.5			
	393.3	13	3.6	3.56	2.5			
	429.4	12	3.8	3.26	2.5			
	471.4	11	3.8	2.97	2.5			
	494.7	11	3.7	2.83	2.5			
	549.0	10	3.8	2.55	2.5			
	606.1	9	3.7	2.31	2.5			
	660.4	8	3.8	2.12	2.5			
	50.6	104	0.9	27.66	2.8			
	56.4	93	1.0	24.83	2.8			
	62.4	84	1.1	22.44	2.8			
	68.8	76	1.1	20.35	2.8			
	75.1	70	1.2	18.63	2.8			
	88.9	59	1.4	15.74	2.8			
	103.2	51	1.7	13.56	2.8			
	115.8	45	1.9	12.09	2.8			
	122.7	43	2.0	11.41	2.8			
	129.0	41	2.1	10.85	2.8			
	142.7	37	2.3	9.81	2.8			
	160.0	33	2.7	8.75	2.8			
	179.3	29	2.8	7.81	2.8			
	58.8	82	1.8	47.93	5.5			
	67.1	72	2.1	42.00	5.5			
	73.3	66	2.3	38.46	5.5			
	84.5	57	2.6	33.38	5.5			
	93.5	52	2.9	30.15	5.5			
	105.3	46	3.3	26.79	5.5			
116.6	41	3.6	24.19	5.5				
122.4	39	3.8	23.04	5.5				



P_1 [кВт]	n_2 [мин ⁻¹]	M_2 [Нм]	f_B	i	F_R [кН]	Редуктор				
0.55	29.2	173	1.2	47.93	5.5	A/F 252 - 71M/4C A/F 252 - 80M/4A	20	77		
	33.3	151	1.3	42.00	5.5					
	36.4	139	1.4	38.46	5.5					
	41.9	120	1.7	33.38	5.5					
	46.4	109	1.8	30.15	5.5					
	52.3	96	2.1	26.79	5.5					
	57.9	87	2.3	24.19	5.5					
	60.8	83	2.4	23.04	5.5					
	69.3	73	2.8	20.19	5.5					
	75.7	67	3.0	18.49	5.5					
	82.1	61	3.1	17.05	5.5					
	93.9	54	3.2	14.91	5.5					
	100.4	50	3.4	13.94	5.5					
	117.0	43	3.4	11.97	5.5					
	135.7	37	3.8	10.32	5.4					
23.7	213	0.9	38.46	5.5	A252 - 80M/6B F252 - 80M/6B	22	77			
27.6	183	1.1	33.38	5.5						
30.5	165	1.2	30.15	5.5						
34.3	147	1.4	26.79	5.5						
38.0	133	1.5	24.19	5.5						
39.9	126	1.6	23.04	5.5						
45.6	111	1.8	20.19	5.5						
49.8	101	2.0	18.49	5.5						
54.0	93	2.0	17.05	5.5						
61.7	82	2.1	14.91	5.5						
66.0	76	2.2	13.94	5.5						
76.9	66	2.2	11.97	5.5						
89.1	57	2.5	10.32	5.4						
102.0	49	2.6	9.02	5.2						
116.0	43	2.9	7.93	5.0						
144.7	35	3.0	6.36	4.7						
191.7	26	3.6	4.80	4.4						
37.7	125	1.2	74.76	5.5	A253 - 71M/2B F253 - 71M/2B	20	77			
42.4	112	1.3	66.56	5.5						
52.8	90	1.7	53.41	5.5						
26.2	192	1.0	53.41	5.5	A/F 253 - 71M/4C A/F 253 - 80M/4A	20	77			
317.9	16	2.7	8.87	1.0	A301 - 71M/2B F301 - 71M/2B	16	79			
362.5	14	2.8	7.78	1.0						
456.3	11	3.5	6.18	1.0						
505.4	10	3.8	5.58	1.0						
555.1	9	3.8	5.08	1.0						
157.8	32	1.7	8.87	1.0	A/F 301 - 71M/4C A/F 301 - 80M/4A	16	79			
179.9	28	1.8	7.78	1.0						
226.5	22	2.2	6.18	1.0						
250.9	20	2.5	5.58	1.0						
275.6	18	2.4	5.08	1.0						
327.9	16	2.9	4.27	1.0						
383.6	13	3.4	3.65	1.0						
443.0	11	3.5	3.16	1.0						
507.2	10	3.0	2.76	0.9						
540.5	9	3.2	2.59	0.9						
686.3	7	3.4	2.04	0.9						
103.7	49	1.1	8.87	1.0	A301 - 80M/6B F301 - 80M/6B	18	79			
118.3	43	1.2	7.78	1.0						
148.9	34	1.5	6.18	1.0						
164.9	31	1.6	5.58	1.0						
181.1	28	1.6	5.08	1.0						
215.5	24	1.9	4.27	1.0						
252.1	20	2.2	3.65	1.0						
291.1	17	2.3	3.16	1.0						
333.3	15	2.0	2.76	1.0						
355.2	14	2.1	2.59	1.0						
451.0	11	2.2	2.04	0.9						
625.9	8	3.1	1.47	0.8						

P_1 [кВт]	n_2 [мин ⁻¹]	M_2 [Нм]	f_B	i	F_R [кН]	Редуктор		
0.55	51.2	94	2.2	55.03	6.6	A302 - 71M/2B F302 - 71M/2B	23	81
	58.5	83	2.5	48.22	6.6			
	63.5	76	2.8	44.38	6.6			
	73.6	66	3.2	38.33	6.6			
	81.5	59	3.5	34.62	6.6			
	91.2	53	4.0	30.91	6.6			
	25.4	198	1.4	55.03	6.6	A/F 302 - 71M/4C A/F 302 - 80M/4A	23	81
	29.0	174	1.6	48.22	6.6			
	31.5	160	1.8	44.38	6.6			
	36.5	138	2.0	38.33	6.6			
	40.4	125	2.2	34.62	6.6			
	45.3	111	2.5	30.91	6.6			
	50.1	101	2.8	27.92	6.6			
	52.9	95	2.7	26.45	6.6			
	59.6	85	3.1	23.49	6.6			
	65.6	77	3.3	21.33	6.6			
	72.6	69	3.6	19.29	6.6			
	16.7	302	0.9	55.03	6.6			
	19.1	264	1.1	48.22	6.6			
	20.7	243	1.2	44.38	6.6			
	24.0	210	1.3	38.33	6.6			
	26.6	190	1.5	34.62	6.6			
	29.8	169	1.7	30.91	6.6			
	33.0	153	1.8	27.92	6.6			
	34.8	145	1.8	26.45	6.6			
	39.2	129	2.0	23.49	6.6			
	43.1	117	2.1	21.33	6.6			
	47.7	106	2.4	19.29	6.6			
	56.8	89	2.8	16.21	6.6			
	66.6	76	3.3	13.81	6.6			
	76.7	66	3.8	12.00	6.6			
	22.4	211	1.1	125.65	6.6	A303 - 71M/2B F303 - 71M/2B	23	81
	24.6	192	1.2	114.42	6.6			
	32.4	146	1.5	86.96	6.6			
	36.9	128	1.8	76.42	6.6			
	45.8	103	2.2	61.63	6.6			
	12.2	404	0.7	114.42	6.6	A303 - 71M/4C F303 - 71M/4C	23	81
	16.1	307	1.0	86.96	6.6	A/F 303 - 71M/4C A/F 303 - 80M/4A	23	81
	18.3	270	1.1	76.42	6.6			
	22.7	217	1.4	61.63	6.6			
	14.9	331	0.9	61.63	6.6	A303 - 80M/6B F303 - 80M/6B	23	81
	164.7	31	3.2	8.50	2.5	A/F 351 - 71M/4C A/F 351 - 80M/4A	18	83
188.1	27	3.7	7.44	2.5				
108.2	47	2.1	8.50	2.5	A351 - 80M/6B F351 - 80M/6B	20	83	
123.6	41	2.4	7.44	2.5				
155.7	33	3.1	5.91	2.5				
172.5	30	3.4	5.33	2.5				
189.8	27	3.5	4.85	2.5				
49.5	100	3.8	56.95	8.0	A352 - 71M/2B F352 - 71M/2B	28	85	
24.6	201	2.4	56.95	8.0	A/F 352 - 71M/4C A/F 352 - 80M/4A	28	85	
28.1	176	2.8	49.88	8.0				
30.4	162	3.0	46.04	8.0				
35.4	140	3.5	39.59	8.0				
16.2	312	1.6	56.95	8.0	A352 - 80M/6B F352 - 80M/6B	30	85	
18.4	273	1.8	49.88	8.0				
20.0	252	1.9	46.04	8.0				
23.2	217	2.3	39.59	8.0				
27.5	184	2.7	33.50	8.0				
28.7	175	2.8	32.01	8.0				
31.8	158	3.1	28.89	8.0				
34.6	146	3.4	26.59	8.0				
36.6	138	3.4	25.13	8.0				



P_1 [кВт]	n_2 [мин ⁻¹]	M_2 [Нм]	f_B	i	F_R [кН]	Редуктор		
0.55	13.0	363	1.0	216.67	8.0	A353 - 71M/2B F353 - 71M/2B	30	85
	14.5	326	1.1	194.72	8.0			
	17.9	264	1.4	157.42	8.0			
	20.9	226	1.7	134.76	8.0			
	25.9	183	2.1	108.95	8.0			
	31.2	152	2.5	90.51	8.0			
	38.9	122	3.1	72.58	8.0			
	48.1	98	3.8	58.68	8.0			
	8.9	555	0.9	157.42	8.0	A353 - 71M/4C F353 - 71M/4C	30	85
	10.4	475	1.1	134.76	8.0	A/F 353 - 71M/4C A/F 353 - 80M/4A	30	85
	12.8	384	1.3	108.95	8.0			
	15.5	319	1.6	90.51	8.0			
	19.3	256	2.0	72.58	8.0			
	23.9	207	2.4	58.68	8.0			
	10.2	486	1.0	90.51	8.0	A353 - 80M/6B F353 - 80M/6B	30	85
	12.7	390	1.3	72.58	8.0			
	15.7	315	1.6	58.68	8.0			
	111.5	46	3.7	8.25	3.7	A401 - 80M/6B F401 - 80M/6B	20	87
	20.3	249	3.4	45.38	12.0	A402 - 80M/6B F402 - 80M/6B	41	89
	23.2	218	3.9	39.72	12.0			
	10.5	449	1.4	267.75	12.0	A403 - 71M/2B F403 - 71M/2B	38	89
	12.0	393	1.6	234.50	12.0			
	13.1	360	1.8	215.01	12.0			
	15.1	312	2.0	186.14	12.0			
	16.5	286	2.2	170.55	12.0			
	18.9	251	2.5	149.47	12.0			
	20.8	227	2.8	135.37	12.0			
23.9	198	3.2	118.13	12.0				
29.7	159	4.0	94.86	12.0				
5.2	944	0.9	267.75	12.0	A/F 403 - 71M/4C A/F 403 - 80M/4A			
6.0	827	1.0	234.50	12.0				
6.5	758	1.1	215.01	12.0				
7.5	656	1.3	186.14	12.0				
8.2	601	1.4	170.55	12.0				
9.4	527	1.6	149.47	12.0				
10.3	477	1.8	135.37	12.0				
11.9	417	2.0	118.13	12.0				
14.8	335	2.5	94.86	12.0				
16.3	303	2.8	85.91	12.0				
5.4	915	0.9	170.55	12.0	A403 - 80M/6B F403 - 80M/6B	41	89	
6.2	802	1.1	149.47	12.0				
6.8	726	1.2	135.37	12.0				
7.8	634	1.3	118.13	12.0				
9.7	509	1.7	94.86	12.0				
10.7	461	1.8	85.91	12.0				
6.3	785	2.3	222.59	18.0				A503 - 80M/4A F503 - 80M/4A
7.2	687	2.6	194.86	18.0				
7.8	631	2.9	178.98	18.0				
8.6	572	3.1	162.21	18.0				
9.1	545	3.3	154.52	18.0				
9.9	501	3.6	142.00	18.0				
4.1	1195	1.5	222.59	18.0	A503 - 80M/6B F503 - 80M/6B	58	93	
4.7	1046	1.7	194.86	18.0				
5.1	961	1.9	178.98	18.0				
5.7	871	2.1	162.21	18.0				
6.0	829	2.2	154.52	18.0				
6.5	762	2.4	142.00	18.0				
7.4	667	2.7	124.25	18.0				
8.2	604	3.0	112.61	18.0				
9.4	525	3.4	97.80	18.0				
10.8	458	3.9	85.33	18.0				

P_1 [кВт]	n_2 [мин ⁻¹]	M_2 [Нм]	f_B	i	F_R [кН]	Редуктор					
0.75	62.4	115	0.8	22.44	2.8	A 202 G - 80M/4B F 202 G - 80M/4B	14	75			
	68.8	104	0.8	20.35	2.8						
	75.1	95	0.9	18.63	2.8						
	88.9	81	1.1	15.74	2.8						
	103.2	69	1.2	13.56	2.8						
	115.8	62	1.4	12.09	2.8						
	122.7	58	1.5	11.41	2.8						
	129.0	56	1.5	10.85	2.8						
	142.7	50	1.7	9.81	2.8						
	160.0	45	2.0	8.75	2.8						
	179.3	40	2.1	7.81	2.8						
	198.9	36	2.3	7.04	2.8						
	218.4	33	2.5	6.41	2.8						
	243.9	29	2.6	5.74	2.8						
	271.3	26	3.1	5.16	2.8						
	302.4	24	3.0	4.63	2.8						
	334.1	21	3.0	4.19	2.8						
	367.5	19	3.0	3.81	2.8						
	407.0	18	3.1	3.44	2.8						
	432.1	17	3.3	3.24	2.8						
	474.6	15	3.3	2.95	2.8						
	510.9	14	3.3	2.74	2.8						
	557.8	13	3.3	2.51	2.8						
	606.1	12	3.6	2.31	2.8						
	59.3	111	1.3	47.93	5.5				A/F 252 - 71M/2C A/F 252 - 80M/2A	20	77
	67.6	97	1.5	42.00	5.5						
	73.8	89	1.7	38.46	5.5						
	85.1	77	1.9	33.38	5.5						
	94.2	70	2.1	30.15	5.5						
	106.0	62	2.4	26.79	5.5						
	117.4	56	2.7	24.19	5.5						
	123.3	53	2.8	23.04	5.5						
	140.6	47	3.2	20.19	5.4						
	153.6	43	3.5	18.49	5.5						
	166.5	40	3.6	17.05	5.5						
	190.4	35	3.7	14.91	5.5						
	203.8	32	3.9	13.94	5.5						
	237.3	28	3.9	11.97	5.3						
	33.3	206	1.0	42.00	5.5				A252 - 80M/4B F252 - 80M/4B	21	77
	36.4	189	1.1	38.46	5.5						
	41.9	164	1.2	33.38	5.5						
46.4	148	1.4	30.15	5.5							
52.3	132	1.5	26.79	5.5							
57.9	119	1.7	24.19	5.5							
60.8	113	1.8	23.04	5.5							
69.3	99	2.0	20.19	5.4							
75.7	91	2.2	18.49	5.5							
82.1	84	2.3	17.05	5.5							
93.9	73	2.3	14.91	5.5							
100.4	68	2.5	13.94	5.5							
117.0	59	2.5	11.97	5.3							
135.7	51	2.8	10.32	5.2							
155.2	44	2.9	9.02	5.0							
176.5	39	3.2	7.93	4.9							
220.0	31	3.4	6.36	4.6							
30.7	224	0.9	30.15	5.5	A/F 252 - 80C/6 A/F 252 - 90S/6A	21	77				
34.5	199	1.0	26.79	5.5							
38.2	180	1.1	24.19	5.5							
40.1	171	1.2	23.04	5.5							
45.8	150	1.3	20.19	5.5							
50.0	137	1.5	18.49	5.5							
54.2	127	1.5	17.05	5.5							
62.0	111	1.5	14.91	5.5							
66.4	104	1.6	13.94	5.5							
77.3	89	1.6	11.97	5.3							
89.7	77	1.8	10.32	5.2							
102.5	67	1.9	9.02	5.0							
116.6	59	2.1	7.93	4.9							
145.3	47	2.2	6.36	4.6							
192.8	36	2.7	4.80	4.3							



P_1 [кВт]	n_2 [мин ⁻¹]	M_2 [Нм]	f_B	i	F_R [кН]	Редуктор		
0.75	53.2	121	1.2	53.41	5.5	A/F 253 - 71M/2C A/F 253 - 80M/2A	20	77
	320.2	21	2.0	8.87	1.0	A/F 301 - 71M/2C A/F 301 - 80M/2A	16	79
	365.0	18	2.0	7.78	1.0			
	459.5	15	2.6	6.18	1.0			
	509.0	13	2.8	5.58	1.0			
	559.1	12	2.8	5.08	1.0			
	665.1	10	3.3	4.27	1.0			
	778.7	9	3.9	3.65	1.0			
	899.3	7	4.0	3.16	1.0			
	1028.3	7	3.4	2.76	0.9			
1096.1	6	3.7	2.59	0.9				
1393.2	5	3.9	2.04	0.8				
157.8	44	1.2	8.87	1.0	A301 - 80M/4B F301 - 80M/4B	17	79	
179.9	39	1.3	7.78	1.0				
226.5	31	1.6	6.18	1.0				
250.9	28	1.8	5.58	1.0				
275.6	25	1.8	5.08	1.0				
327.9	21	2.1	4.27	1.0				
383.9	18	2.5	3.65	1.0				
443.3	16	2.6	3.16	1.0				
506.9	14	2.2	2.76	0.9				
540.4	13	2.3	2.59	0.9				
686.8	10	2.5	2.04	0.8				
953.2	7	3.4	1.47	0.8				
118.9	58	0.9	7.78	1.0				A/F 301 - 80C/6 A/F 301 - 90S/6A
149.6	46	1.1	6.18	1.0				
165.7	42	1.2	5.58	1.0				
182.2	38	1.2	5.08	1.0				
216.8	32	1.4	4.27	1.0				
253.6	27	1.6	3.65	1.0				
292.9	24	1.7	3.16	1.0				
334.9	21	1.4	2.76	1.0				
357.0	19	1.5	2.59	1.0				
453.8	15	1.6	2.04	0.9				
629.8	11	2.3	1.47	0.8				
51.6	128	1.6	55.03	6.6	A/F 302 - 71M/2C A/F 302 - 80M/2A	23	81	
58.9	112	1.9	48.22	6.6				
64.0	103	2.0	44.38	6.6				
74.1	89	2.4	38.33	6.6				
82.0	80	2.6	34.62	6.6				
91.9	72	2.9	30.91	6.6				
101.7	65	3.2	27.92	6.6				
107.4	61	3.2	26.45	6.6				
120.9	55	3.6	23.49	6.6				
133.1	49	3.8	21.33	6.6				
25.4	270	1.0	55.03	6.6				A302 - 80M/4B F302 - 80M/4B
29.0	237	1.2	48.22	6.6				
31.5	218	1.3	44.38	6.6				
36.5	188	1.5	38.33	6.6				
40.4	170	1.6	34.62	6.6				
45.3	152	1.8	30.91	6.6				
50.1	137	2.0	27.92	6.6				
52.9	130	2.0	26.45	6.6				
59.6	115	2.3	23.49	6.6				
65.6	105	2.4	21.33	6.6				
72.6	95	2.6	19.29	6.6				
86.3	80	3.1	16.21	6.6				
101.4	68	3.7	13.81	6.6				

P_1 [кВт]	n_2 [мин ⁻¹]	M_2 [Нм]	f_B	i	F_R [кН]	Редуктор		
0.75	24.1	285	1.0	38.33	6.6	A/F 302 - 80C/6 A/F 302 - 90S/6A	27	81
	26.7	257	1.1	34.62	6.6			
	29.9	230	1.2	30.91	6.6			
	33.1	208	1.3	27.92	6.6			
	35.0	197	1.3	26.45	6.6			
	39.4	175	1.5	23.49	6.6			
	43.4	159	1.6	21.33	6.6			
	47.9	143	1.7	19.29	6.6			
	57.1	121	2.1	16.21	6.6			
	67.0	103	2.4	13.81	6.6			
	77.1	89	2.8	12.00	6.6			
	88.1	78	3.1	10.50	6.6			
	101.6	68	3.1	9.11	6.6			
	126.0	55	2.9	7.34	6.2			
	165.7	41	3.9	5.58	5.7			
32.7	206	1.1	86.96	6.6	A/F 303 - 71M/2C A/F 303 - 80M/2A	23	81	
37.2	181	1.3	76.42	6.6				
46.1	146	1.6	61.63	6.6				
22.7	296	1.0	61.63	6.6	A303 - 80M/4B F303 - 80M/4B	24	81	
334.1	21	3.8	8.50	2.5	A/F 351 - 71M/2C A/F 351 - 80M/2A	18	83	
164.7	42	2.4	8.50	2.5	A351 - 80M/4B F351 - 80M/4B	19	83	
188.1	37	2.7	7.44	2.5				
236.9	29	3.4	5.91	2.5				
262.5	26	3.8	5.33	2.5				
108.8	64	1.6	8.50	2.5	A/F 351 - 80C/6 A/F 351 - 90S/6A	22	83	
124.3	56	1.8	7.44	2.5				
156.5	44	2.3	5.91	2.5				
173.4	40	2.5	5.33	2.5				
190.9	36	2.6	4.85	2.5				
227.5	31	2.9	4.07	2.5				
246.7	28	3.2	3.75	2.5				
287.1	24	3.3	3.22	2.5				
353.2	20	3.6	2.62	2.3				
426.9	16	3.7	2.17	2.2				
49.9	132	2.8	56.95	8.0	A/F 352 - 71M/2C A/F 352 - 80M/2A	28	85	
56.9	116	3.2	49.88	8.0				
61.7	107	3.4	46.04	8.0				
71.7	92	4.0	39.59	8.0				
24.6	280	1.8	56.95	8.0	A352 - 80M/4B F352 - 80M/4B	29	85	
28.1	245	2.0	49.88	8.0				
30.4	226	2.2	46.04	8.0				
35.4	194	2.5	39.59	8.0				
41.8	165	3.0	33.50	8.0				
43.7	157	3.1	32.01	8.0				
48.5	142	3.5	28.89	8.0				
52.6	131	3.8	26.59	8.0				
55.7	123	3.8	25.13	8.0				
16.2	423	1.2	56.95	8.0				A/F 352 - 80C/6 A/F 352 - 90S/6A
18.5	371	1.3	49.88	8.0				
20.1	342	1.4	46.04	8.0				
23.4	294	1.7	39.59	8.0				
27.6	249	2.0	33.50	8.0				
28.9	238	2.1	32.01	8.0				
32.0	215	2.3	28.89	8.0				
34.8	198	2.5	26.59	8.0				
36.8	187	2.5	25.13	8.0				
42.0	164	2.9	22.03	8.0				
45.5	151	3.0	20.31	8.0				
50.5	136	3.4	18.30	8.0				
54.8	125	3.6	16.88	8.0				
18.0	357	1.0	157.42	8.0	A353 - 71M/2C F353 - 71M/2C	28	85	



P_1 [кВт]	n_2 [мин ⁻¹]	M_2 [Нм]	f_B	i	F_R [кН]	Редуктор		
0.75	21.1	306	1.2	134.76	8.0	A/F 353 - 80C/6 A/F 353 - 90S/6A	32	85
	26.1	247	1.5	108.95	8.0			
	31.4	205	1.8	90.51	8.0			
	39.1	165	2.3	72.58	8.0			
	48.4	133	2.8	58.68	8.0			
	12.8	524	1.0	108.95	8.0	A353 - 80M/4B F353 - 80M/4B	29	85
	15.5	435	1.1	90.51	8.0			
	19.3	349	1.4	72.58	8.0			
	23.9	282	1.8	58.68	8.0			
	12.7	528	0.9	72.58	8.0	A/F 353 - 80C/6 A/F 353 - 90S/6A	32	85
	15.8	427	1.2	58.68	8.0			
	112.1	62	2.7	8.25	3.7	A/F 401 - 80C/6 A/F 401 - 90S/6A	22	87
	128.1	54	3.1	7.22	3.7			
	161.5	43	4.0	5.73	3.7			
	30.9	223	3.8	45.38	12.0	A402 - 80M/4B F402 - 80M/4B	40	89
	20.4	337	2.5	45.38	12.0	A/F 402 - 80C/6 A/F 402 - 90S/6A	43	89
	23.3	295	2.9	39.72	12.0			
	25.4	271	3.1	36.44	12.0			
	29.4	234	3.6	31.50	12.0			
	32.0	215	4.0	28.89	12.0			
	10.6	608	1.0	267.75	12.0	A403 - 71M/2C F403 - 71M/2C	38	89
	12.1	533	1.2	234.67	12.0	A/F 403 - 71M/2C A/F 403 - 80M/2A	38	89
	13.2	488	1.3	215.21	12.0			
	15.3	423	1.5	186.14	12.0			
	16.7	387	1.6	170.55	12.0			
	19.0	339	1.9	149.47	12.0			
	21.0	307	2.1	135.37	12.0			
	24.0	268	2.4	118.13	12.0			
29.9	215	3.0	94.86	12.0				
33.1	195	3.3	85.91	12.0				
7.5	895	0.9	186.14	12.0	A403 - 80M/4B F403 - 80M/4B			
8.2	820	1.0	170.55	12.0				
9.4	719	1.2	149.47	12.0				
10.3	651	1.3	135.37	12.0				
11.9	568	1.5	118.13	12.0				
14.8	456	1.9	94.86	12.0				
16.3	413	2.1	85.91	12.0				
7.8	860	1.0	118.13	12.0	A/F 403 - 80C/6 A/F 403 - 90S/6A	43	89	
9.8	690	1.2	94.86	12.0				
10.8	625	1.4	85.91	12.0				
13.6	497	1.7	68.25	12.0	A403 - 90S/6A F403 - 90S/6A	43	89	
16.9	399	2.1	54.81	12.0				
18.6	361	2.4	49.64	12.0				
12.8	505	2.7	222.59	18.0	A503 - 80M/2A F503 - 80M/2A	57	93	
14.6	442	3.1	194.86	18.0				
15.9	406	3.3	178.98	18.0				
17.5	368	3.7	162.21	18.0				
18.4	351	3.8	154.52	18.0				
6.3	1070	1.7	222.59	18.0	A503 - 80M/4B F503 - 80M/4B	57	93	
7.2	937	1.9	194.86	18.0				
7.8	861	2.1	178.98	18.0				
8.6	780	2.3	162.21	18.0				
9.1	743	2.4	154.52	18.0				
9.9	683	2.6	142.00	18.0				
11.3	598	3.0	124.25	18.0				
12.4	542	3.3	112.61	18.0				
14.3	470	3.8	97.80	18.0				

P_1 [кВт]	n_2 [мин ⁻¹]	M_2 [Нм]	f_B	i	F_R [кН]	Редуктор		
0.75	4.2	1620	1.1	222.59	18.0	A/F 503 - 80C/6 A/F 503 - 90S/6A	60	93
	4.7	1418	1.3	194.86	18.0			
	5.2	1303	1.4	178.98	18.0			
	5.7	1181	1.5	162.21	18.0			
	6.0	1125	1.6	154.52	18.0			
	6.5	1034	1.7	142.00	18.0			
	7.4	904	2.0	124.25	18.0			
	8.2	820	2.2	112.61	18.0			
	9.5	712	2.5	97.80	18.0			
	10.8	621	2.9	85.33	18.0			
	11.8	572	3.1	78.64	18.0			
	13.0	519	3.5	71.27	18.0			
	16.5	409	3.9	56.21	18.0			
	3.8	1766	2.0	242.67	22.0			
	4.3	1569	2.2	215.56	22.0			
	4.8	1414	2.5	194.31	22.0			
	5.1	1318	2.7	181.13	22.0			
	5.7	1171	3.0	160.90	22.0			
	6.4	1045	3.3	143.57	22.0			
0.92	42.2	200	1.0	33.38	5.5	A252 - 80M/4 F252 - 80M/4	21	77
	46.8	180	1.1	30.15	5.5			
	52.6	160	1.2	26.79	5.4			
	58.3	145	1.4	24.19	5.4			
	61.2	138	1.5	23.04	5.3			
	69.8	121	1.7	20.19	5.2			
	76.3	111	1.8	18.49	5.1			
	94.6	89	1.9	14.91	4.9			
	101.1	83	2.0	13.94	4.9			
	117.8	72	2.0	11.97	4.7			
	136.7	62	2.3	10.32	4.5			
	156.3	54	2.4	9.02	4.4			
	177.8	47	2.6	7.93	4.2			
	221.5	38	2.8	6.36	4.0			
	293.9	29	3.3	4.80	3.7			
	159.0	54	1.0	8.87	1.0			
	181.2	47	1.1	7.78	1.0			
	228.1	37	1.3	6.18	1.0			
	252.7	34	1.5	5.58	1.0			
	277.6	31	1.5	5.08	0.9			
	330.2	26	1.7	4.27	0.9			
	386.3	22	2.0	3.65	0.9			
	446.2	19	2.1	3.16	0.8			
	510.9	17	1.8	2.76	0.8			
	544.4	16	1.9	2.59	0.8			
	691.2	12	2.0	2.04	0.7			
	959.2	9	2.8	1.47	0.7			
	29.2	288	1.0	48.22	6.6			
	31.8	265	1.1	44.38	6.6			
	36.8	229	1.2	38.33	6.6			
	40.7	207	1.4	34.62	6.6			
	45.6	185	1.5	30.91	6.6			
	50.5	167	1.7	27.92	6.6			
	53.3	158	1.6	26.45	6.6			
	60.0	141	1.9	23.49	6.6			
	66.1	128	2.0	21.33	6.6			
	73.1	115	2.2	19.29	6.6			
	87.0	97	2.6	16.21	6.6			
	102.1	83	3.0	13.81	6.4			
	117.5	72	3.5	12.00	6.2			
	134.3	63	3.8	10.50	5.9			
	154.8	54	3.9	9.11	5.7			
	192.0	44	3.6	7.34	5.4			
	165.9	51	1.9	8.50	2.5			
	189.5	45	2.2	7.44	2.5			
238.6	36	2.8	5.91	2.5				
264.4	32	3.1	5.33	2.5				
291.0	29	3.2	4.85	2.5				
346.7	25	3.7	4.07	2.3				
						A301 - 80M/4 F301 - 80M/4	17	79
						A302 - 80M/4 F302 - 80M/4	24	81
						A351 - 80M/4 F351 - 80M/4	19	83



P_1 [кВт]	n_2 [мин ⁻¹]	M_2 [Нм]	f_B	i	F_R [кН]	Редуктор					
0.92	24.8	341	1.4	56.95	8.0	A352 - 80M/4 F352 - 80M/4	29	85			
	28.3	298	1.6	49.88	8.0						
	30.6	275	1.8	46.04	8.0						
	35.6	237	2.1	39.59	8.0						
	42.1	200	2.4	33.50	8.0						
	44.1	191	2.6	32.01	8.0						
	48.8	173	2.8	28.89	8.0						
	53.0	159	3.1	26.59	8.0						
	56.1	150	3.1	25.13	8.0						
	64.0	132	3.6	22.03	8.0						
	69.4	122	3.8	20.31	8.0						
	15.6	530	0.9	90.51	8.0				A353 - 80M/4 F353 - 80M/4	29	85
	19.4	425	1.2	72.58	8.0						
	24.0	344	1.5	58.68	8.0						
	170.9	53	3.2	8.25	3.7	A401 - 80M/4 F401 - 80M/4	29	87			
	195.2	46	3.7	7.22	3.7						
	31.1	295	2.9	45.38	12.0	A402 - 80M/4 F402 - 80M/4	29	89			
	35.5	258	3.3	39.72	12.0						
	38.7	237	3.4	36.44	12.0						
	9.4	875	1.0	149.47	12.0	A403 - 80M/4 F403 - 80M/4	40	89			
	10.4	793	1.1	135.37	12.0						
	11.9	692	1.2	118.13	12.0						
	14.9	556	1.5	94.86	12.0						
	16.4	503	1.7	85.91	12.0						
6.3	1304	1.4	222.59	18.0							
7.2	1141	1.6	194.86	18.0	A503 - 80M/4 F503 - 80M/4	57	93				
7.9	1048	1.7	178.98	18.0							
8.7	950	1.9	162.21	18.0							
9.1	905	2.0	154.52	18.0							
9.9	941	1.9	142.00	18.0							
11.3	824	2.2	124.25	18.0							
12.5	746	2.4	112.61	18.0							
14.4	648	2.8	97.80	18.0							
16.5	566	3.2	85.33	18.0							
17.9	521	3.5	78.64	18.0							
1.10	123.6	85	1.0	11.41				2.8	A 202 G - 90S/4A F 202 G - 90S/4A	17	75
	143.7	73	1.2	9.81				2.8			
	161.1	65	1.3	8.75	2.8						
	180.5	58	1.4	7.81	2.8						
	200.3	52	1.6	7.04	2.8						
	220.0	48	1.7	6.41	2.8						
	245.6	43	1.8	5.74	2.8						
	273.3	38	2.2	5.16	2.8						
	304.5	34	2.1	4.63	2.8						
	336.5	31	2.1	4.19	2.8						
	370.1	28	2.1	3.81	2.8						
	409.9	26	2.1	3.44	2.8						
	435.2	24	2.2	3.24	2.8						
	478.0	22	2.3	2.95	2.8						
	514.6	20	2.3	2.74	2.8						
	561.8	19	2.3	2.51	2.8						
	610.4	17	2.5	2.31	2.8						
	67.9	142	1.1	42.00	5.0	A252 - 80M/2B F252 - 80M/2B	21	77			
	74.1	130	1.2	38.46	5.0						
	85.4	113	1.3	33.38	4.9						
	94.5	102	1.5	30.15	4.8						
	106.4	91	1.7	26.79	4.7						
	117.8	82	1.8	24.19	4.6						
	123.7	78	1.9	23.04	4.5						
	141.1	68	2.2	20.19	4.4						
	154.1	63	2.4	18.49	4.3						
	167.1	58	2.5	17.05	4.2						
	191.1	51	2.5	14.91	4.1						
	204.5	47	2.7	13.94	4.0						
	238.1	41	2.7	11.97	3.9						
276.3	35	3.0	10.32	3.7							
315.9	31	3.2	9.02	3.6							
359.3	27	3.5	7.93	3.5							
447.8	22	3.6	6.36	3.3							

P_1 [кВт]	n_2 [мин ⁻¹]	M_2 [Нм]	f_B	i	F_R [кН]	Редуктор		
1.10	46.8	216	0.9	30.15	5.1	A/F 252 - 80M/4C A/F 252 - 90S/4A	24	77
	52.6	192	1.0	26.79	5.1			
	58.3	173	1.2	24.19	5.1			
	61.2	165	1.2	23.04	5.0			
	69.8	144	1.4	20.19	5.0			
	76.3	132	1.5	18.49	4.9			
	82.7	122	1.6	17.05	4.8			
	94.6	107	1.6	14.91	4.7			
	101.1	100	1.7	13.94	4.7			
	117.8	86	1.7	11.97	4.5			
	136.6	74	1.9	10.32	4.4			
	156.3	65	2.0	9.02	4.3			
	177.8	57	2.2	7.93	4.2			
	221.5	46	2.3	6.36	3.9			
	293.9	34	2.8	4.80	3.7			
		46.3	220	0.9	20.19			
50.6		201	1.0	18.49	5.1			
54.8		186	1.0	17.05	5.1			
62.7		163	1.0	14.91	5.0			
67.1		152	1.1	13.94	5.0			
78.1		130	1.1	11.97	4.9			
90.6		112	1.2	10.32	4.8			
103.6		98	1.3	9.02	4.7			
117.9		86	1.4	7.93	4.6			
146.9		69	1.5	6.36	4.4			
194.9		52	1.8	4.80	4.1			
		321.1	31	1.3	8.88	0.9	A301 - 80M/2B F301 - 80M/2B	17
	366.3	27	1.4	7.78	0.9			
	461.2	21	1.8	6.18	0.9			
	510.8	19	1.9	5.58	0.8			
	561.0	18	1.9	5.08	0.8			
	667.4	15	2.3	4.27	0.8			
	780.8	13	2.7	3.65	0.8			
	901.9	11	2.7	3.16	0.7			
	1032.6	10	2.4	2.76	0.7			
	1100.4	9	2.5	2.59	0.7			
	1397.1	7	2.7	2.04	0.6			
	1938.8	5	3.7	1.47	0.5			
	181.2	56	0.9	7.78	1.0	A/F 301 - 80M/4C A/F 301 - 90S/4A	20	79
	228.2	45	1.1	6.18	1.0			
	252.7	40	1.2	5.58	1.0			
	277.6	37	1.2	5.08	1.0			
	330.2	31	1.5	4.27	0.9			
	386.3	26	1.7	3.65	0.9			
	446.2	23	1.8	3.16	0.9			
	510.9	20	1.5	2.76	0.8			
	544.4	19	1.6	2.59	0.8			
	691.2	15	1.7	2.04	0.8			
	959.2	11	2.4	1.47	0.7			
		219.0	47	1.0	4.27			
256.2		40	1.1	3.65	1.0			
295.9		34	1.2	3.16	1.0			
338.8		30	1.0	2.76	0.9			
361.0		28	1.1	2.59	0.9			
458.3		22	1.1	2.04	0.9			
636.1		16	1.6	1.47	0.8			
	51.8	187	1.1	55.03	6.6	A302 - 80M/2B F302 - 80M/2B	24	81
	59.1	164	1.3	48.22	6.6			
	64.2	150	1.4	44.38	6.6			
	74.4	130	1.6	38.33	6.6			
	82.3	117	1.8	34.62	6.6			
	92.2	105	2.0	30.91	6.6			
	102.1	95	2.2	27.92	6.6			
	107.7	90	2.2	26.45	6.6			
	121.3	80	2.4	23.49	6.6			
	133.6	72	2.6	21.33	6.6			
	147.7	65	2.9	19.29	6.6			
	175.8	55	3.4	16.21	6.5			
206.4	47	4.0	13.81	6.3				



P_1 [кВт]	n_2 [мин ⁻¹]	M_2 [Нм]	f_B	i	F_R [кН]	Редуктор		
1.10	36.8	274	1.0	38.33	6.6	A/F 302 - 80M/4C A/F 302 - 90S/4A	27	81
	40.7	248	1.1	34.62	6.6			
	45.6	221	1.3	30.91	6.6			
	50.5	200	1.4	27.92	6.6			
	53.3	189	1.4	26.45	6.6			
	60.0	168	1.5	23.49	6.6			
	66.1	153	1.6	21.33	6.6			
	73.1	138	1.8	19.29	6.6			
	87.0	116	2.2	16.21	6.5			
	102.1	99	2.5	13.81	6.3			
117.5	86	2.9	12.00	6.1				
134.3	75	3.2	10.50	5.8				
154.8	65	3.2	9.11	5.6				
192.0	53	3.0	7.34	5.3				
1.10	33.5	301	0.9	27.92	6.6	A302 - 90L/6B F302 - 90L/6B	31	81
	35.3	285	0.9	26.45	6.6			
	39.8	253	1.0	23.49	6.6			
	43.8	230	1.1	21.33	6.6			
	48.5	208	1.2	19.29	6.6			
	57.7	175	1.4	16.21	6.6			
	67.7	149	1.7	13.81	6.6			
	77.9	129	1.9	12.00	6.6			
	89.1	113	2.1	10.50	6.5			
	102.7	98	2.1	9.11	6.3			
127.3	79	2.0	7.34	6.0				
167.5	60	2.7	5.58	5.5				
46.2	204	1.1	61.63	6.6	A303 - 80M/2B F303 - 80M/2B	24	81	
335.3	29	2.5	8.50	2.5	A351 - 80M/2B F351 - 80M/2B	19	83	
382.8	26	2.9	7.44	2.5				
482.3	20	3.7	5.91	2.5				
165.9	61	1.6	8.50	2.5	A/F 351 - 80M/4C A/F 351 - 90S/4A	22	83	
189.4	54	1.9	7.44	2.5				
238.6	43	2.3	5.91	2.5				
264.4	39	2.6	5.33	2.5				
291.0	35	2.7	4.85	2.5				
346.7	29	3.1	4.07	2.5				
376.0	27	3.3	3.75	2.5				
437.6	23	3.4	3.22	2.4				
538.4	19	3.7	2.62	2.3				
650.8	16	3.8	2.17	2.2				
110.0	93	1.1	8.50	2.5	A351 - 90L/6B F351 - 90L/6B	26	83	
125.6	81	1.2	7.44	2.5				
158.2	64	1.6	5.91	2.5				
175.3	58	1.7	5.33	2.5				
192.9	53	1.8	4.85	2.5				
229.9	44	2.0	4.07	2.5				
249.3	41	2.2	3.75	2.5				
290.2	35	2.3	3.22	2.5				
357.0	29	2.5	2.62	2.5				
431.5	24	2.5	2.17	2.4				
644.1	16	3.8	1.45	1.9				
717.6	14	2.8	1.30	2.0				
50.0	193	1.9	56.95	8.0	A352 - 80M/2B F352 - 80M/2B	29	85	
57.1	169	2.2	49.88	8.0				
61.9	156	2.4	46.04	8.0				
72.0	134	2.7	39.59	8.0				
85.1	114	3.2	33.50	8.0				
89.0	109	3.4	32.01	8.0				
98.7	98	3.8	28.89	8.0				

P_1 [кВт]	n_2 [мин ⁻¹]	M_2 [Нм]	f_B	i	F_R [кН]	Редуктор						
1.10	24.8	407	1.2	56.95	8.0	A/F 352 - 80M/4C A/F 352 - 90S/4A	32	85				
	28.3	357	1.4	49.88	8.0							
	30.6	329	1.5	46.04	8.0							
	35.6	283	1.7	39.59	8.0							
	42.1	240	2.0	33.50	8.0							
	44.0	229	2.1	32.01	8.0							
	48.8	207	2.4	28.89	8.0							
	53.0	190	2.6	26.59	8.0							
	56.1	180	2.6	25.13	8.0							
	64.0	158	3.0	22.03	8.0							
	69.4	145	3.2	20.31	8.0							
	77.0	131	3.5	18.30	8.0							
	83.6	121	3.7	16.88	8.0							
		18.7	538	0.9	49.88				8.0	A352 - 90L/6B F352 - 90L/6B	36	85
		20.3	497	1.0	46.04				8.0			
23.6		427	1.1	39.59	8.0							
27.9		361	1.4	33.50	8.0							
29.2		345	1.4	32.01	8.0							
32.4		312	1.6	28.89	8.0							
35.2		287	1.7	26.59	8.0							
37.2		271	1.7	25.13	8.0							
42.4		238	2.0	22.03	8.0							
46.0		219	2.1	20.31	8.0							
51.1		197	2.3	18.30	8.0							
55.4		182	2.5	16.88	8.0							
64.4		157	2.7	14.52	8.0							
79.7		127	3.1	11.74	8.0							
95.9		105	3.5	9.75	8.0							
	107.1	94	3.6	8.73	8.0	A353 - 80M/2B F353 - 80M/2B	29	85				
	132.5	76	3.8	7.06	7.6							
	26.2	361	1.0	108.95	8.0							
	31.5	300	1.2	90.51	8.0							
	39.3	241	1.6	72.58	8.0							
	48.6	195	1.9	58.68	8.0	A/F 353 - 80M/4C A/F 353 - 90S/4A	32	85				
	19.4	508	1.0	72.58	8.0							
	24.0	411	1.2	58.68	8.0	A/F 401 - 80M/4C A/F 401 - 90S/4A	22	87				
	170.9	60	2.9	8.25	3.7							
	195.2	52	3.3	7.22	3.7	A401 - 90L/6B F401 - 90L/6B	26	87				
	113.3	90	1.9	8.25	3.7							
	129.5	79	2.2	7.22	3.7							
	163.3	62	2.7	5.73	3.7							
	181.0	56	3.0	5.17	3.7							
	199.3	51	3.1	4.69	3.7							
	237.7	43	3.5	3.93	3.7							
	257.9	40	3.8	3.63	3.7							
300.5	34	3.8	3.11	3.7								
	62.8	161	4.1	45.38	12.0	A402 - 80M/2B F402 - 80M/2B	40	89				
	31.1	325	2.6	45.38	12.0							
	35.5	284	3.0	39.72	12.0	A/F 402 - 80M/4C A/F 402 - 90S/4A	43	89				
	38.7	261	3.1	36.44	12.0							
	44.8	225	3.8	31.50	12.0							
	48.8	207	3.9	28.89	12.0							
	20.6	489	1.7	45.38	12.0							
	23.5	428	2.0	39.72	12.0	A402 - 90L/6B F402 - 90L/6B	47	89				
	25.7	393	2.0	36.44	12.0							
	29.7	340	2.5	31.50	12.0							
	32.4	312	2.6	28.89	12.0							
	37.0	273	3.1	25.30	12.0							
	40.8	247	3.4	22.91	12.0							
	46.9	215	4.0	19.94	12.0							

P_1 [кВт]	n_2 [мин ⁻¹]	M_2 [Нм]	f_B	i	F_R [кН]	Редуктор		
1.10	15.3	617	1.0	186.14	12.0	A403 - 80M/2B F403 - 80M/2B	40	89
	16.7	566	1.1	170.55	12.0			
	19.1	496	1.3	149.47	12.0			
	21.1	449	1.4	135.37	12.0			
	24.1	392	1.6	118.13	12.0			
	30.0	315	2.0	94.86	12.0			
	33.2	285	2.2	85.91	12.0			
	11.9	827	1.0	118.13	12.0	A/F 403 - 80M/4C A/F 403 - 90S/4A	43	89
	14.9	664	1.3	94.86	12.0			
	16.4	602	1.4	85.91	12.0			
	10.9	907	0.9	85.91	12.0	A403 - 90L/6B F403 - 90L/6B	47	89
	13.7	721	1.2	68.25	12.0			
	17.1	579	1.5	54.81	12.0			
	18.8	524	1.6	49.64	12.0			
	20.7	478	1.8	68.25	12.0	A403 - 90S/4A F403 - 90S/4A	43	89
	25.7	384	2.2	54.81	12.0			
	28.4	348	2.4	49.64	12.0			
	109.3	93	3.8	8.56	4.0	A501 - 90L/6B F501 - 90L/6B	37	91
	19.2	526	3.0	48.77	18.0	A502 - 90L/6B F502 - 90L/6B	64	93
	21.6	467	3.4	43.32	18.0			
	23.8	423	3.8	39.21	18.0			
	12.8	738	1.8	222.59	18.0	A503 - 80M/2B F503 - 80M/2B	55	93
	14.6	646	2.1	194.86	18.0			
	15.9	594	2.3	178.98	18.0			
	17.6	538	2.5	162.21	18.0			
	18.4	513	2.6	154.52	18.0			
	20.1	471	2.9	142.00	18.0			
	22.9	412	3.3	124.25	18.0			
	25.3	374	3.6	112.61	18.0			
	6.3	1559	1.2	222.59	18.0			
	7.2	1365	1.3	194.86	18.0			
	7.9	1253	1.4	178.98	18.0			
	8.7	1136	1.6	162.21	18.0			
	9.1	1082	1.7	154.52	18.0			
	9.9	994	1.8	142.00	18.0			
	11.3	870	2.1	124.25	18.0			
	12.5	789	2.3	112.61	18.0			
	14.4	685	2.6	97.80	18.0			
	16.5	598	3.0	85.33	18.0			
	17.9	551	3.3	78.64	18.0			
	19.8	499	3.6	71.27	18.0			
	5.2	1890	1.0	178.98	18.0	A503 - 90L/6B F503 - 90L/6B	64	93
	5.8	1713	1.1	162.21	18.0			
	6.1	1632	1.1	154.52	18.0			
	6.6	1500	1.2	142.00	18.0			
	7.5	1312	1.4	124.25	18.0			
	8.3	1189	1.5	112.61	18.0			
	9.6	1033	1.7	97.80	18.0			
11.0	901	2.0	85.33	18.0				
11.9	831	2.2	78.64	18.0				
13.1	753	2.4	71.27	18.0				
16.6	594	2.7	56.21	18.0				
3.9	2563	1.4	242.67	22.0	A603 - 90L/6B F603 - 90L/6B	92	97	
4.3	2277	1.5	215.56	22.0				
4.8	2052	1.7	194.31	22.0				
5.2	1913	1.8	181.13	22.0				
5.8	1699	2.1	160.90	22.0				
6.5	1516	2.3	143.57	22.0				
5.8	1699	2.1	242.67	22.0	A603 - 90S/4A F603 - 90S/4A	88	97	
6.5	1510	2.3	215.56	22.0				
7.3	1361	2.6	194.31	22.0				
7.8	1269	2.8	181.13	22.0				
8.8	1127	3.1	160.90	22.0				
9.8	1005	3.5	143.57	22.0				



P_1 [кВт]	n_2 [мин ⁻¹]	M_2 [Нм]	f_B	i	F_R [кН]	Редуктор		
1.50	144.8	99	0.9	9.81	2.8	A 202 G - 90L/4A F 202 G - 90L/4A	19	75
	162.3	88	1.0	8.75	2.8			
	181.8	79	1.0	7.81	2.8			
	201.7	71	1.2	7.04	2.8			
	221.5	65	1.3	6.41	2.8			
	247.4	58	1.3	5.74	2.8			
	275.2	52	1.6	5.16	2.8			
	306.7	47	1.5	4.63	2.8			
	338.9	42	1.5	4.19	2.8			
	372.7	38	1.5	3.81	2.8			
	412.8	35	1.6	3.44	2.8			
	438.3	33	1.7	3.24	2.8			
	481.4	30	1.7	2.95	2.8			
	518.2	28	1.7	2.74	2.8			
	565.7	25	1.7	2.51	2.8			
614.7	23	1.8	2.31	2.8				
	91.1	151	0.9	10.32	4.4	A252 - 100L/6A F252 - 100L/6A	33	77
	104.2	132	1.0	9.02	4.3			
	118.5	116	1.1	7.93	4.2			
	147.7	93	1.1	6.36	4.1			
	195.9	70	1.4	4.80	3.9			
	94.9	139	1.1	30.15	4.4	A/F 252 - 80M/2C A/F 252 - 90S/2A	22	77
	106.8	123	1.2	26.79	4.3			
	118.2	111	1.3	24.19	4.3			
	124.1	106	1.4	23.04	4.2			
	141.6	93	1.6	20.19	4.2			
	154.7	85	1.8	18.49	4.1			
	167.7	79	1.8	17.05	4.0			
	191.8	69	1.9	14.91	3.9			
	205.2	64	2.0	13.94	3.9			
	239.0	55	2.0	11.97	3.7			
	277.2	48	2.2	10.32	3.6			
	317.0	42	2.3	9.02	3.5			
	360.6	37	2.6	7.93	3.4			
449.4	29	2.7	6.36	3.2				
596.1	22	3.2	4.80	3.0				
	70.3	196	1.0	20.19	4.4	A252 - 90L/4A F252 - 90L/4A	26	77
	76.8	179	1.1	18.49	4.4			
	83.3	165	1.2	17.05	4.4			
	95.2	144	1.2	14.91	4.3			
	101.9	135	1.3	13.94	4.3			
	118.6	116	1.3	11.97	4.2			
	137.6	100	1.4	10.32	4.1			
	157.4	87	1.5	9.02	4.0			
	179.1	77	1.6	7.93	3.9			
	223.3	62	1.7	6.36	3.8			
295.8	46	2.0	4.80	3.5				
322.3	42	1.0	8.88	0.8	A301 - 80M/2C F301 - 80M/2C	17	79	
	367.7	37	1.0	7.78	0.9	A/F 301 - 80M/2C A/F 301 - 90S/2A	18	79
	462.6	29	1.3	6.18	0.8			
	512.2	26	1.4	5.58	0.8			
	563.3	24	1.4	5.08	0.8			
	670.3	20	1.7	4.27	0.8			
	784.2	17	2.0	3.65	0.7			
	905.7	15	2.0	3.16	0.7			
	1035.5	13	1.7	2.76	0.7			
	1103.9	12	1.8	2.59	0.7			
	1403.0	10	2.0	2.04	0.6			
	1947.2	7	2.7	1.47	0.6			
	254.5	55	0.9	5.58	0.9	A301 - 90L/4A F301 - 90L/4A	22	79
	279.5	50	0.9	5.08	0.9			
	332.6	42	1.1	4.27	0.9			
	389.0	36	1.3	3.65	0.9			
	449.4	31	1.3	3.16	0.8			
	514.5	27	1.1	2.76	0.8			
	548.3	25	1.2	2.59	0.8			
	696.1	20	1.3	2.04	0.8			
	966.0	14	1.7	1.47	0.7			



P_1 [кВт]	n_2 [мин ⁻¹]	M_2 [Нм]	f_B	i	F_R [кН]	Редуктор					
1.50	58.0	237	1.1	16.21	6.2	A302 - 100L/6A F302 - 100L/6A	36	81			
	68.1	202	1.2	13.81	6.0						
	78.3	176	1.4	12.00	5.8						
	89.6	154	1.6	10.50	5.6						
	103.2	133	1.6	9.11	5.4						
	128.0	107	1.5	7.34	5.2						
	168.4	82	2.0	5.58	4.8						
	59.3	222	0.9	48.22	6.6				A302 - 80M/2C F302 - 80M/2C	24	81
	74.6	177	1.2	38.33	6.4				A/F 302 - 80M/2C A/F 302 - 90S/2A	25	81
	82.6	160	1.3	34.62	6.3						
92.5	142	1.5	30.91	6.2							
102.4	129	1.6	27.92	6.0							
108.1	122	1.6	26.45	6.0							
121.8	108	1.8	23.49	5.8							
134.1	98	1.9	21.33	5.7							
148.3	89	2.1	19.29	5.5							
176.4	75	2.5	16.21	5.3							
207.1	64	2.9	13.81	5.1							
238.3	55	3.4	12.00	4.9							
272.5	48	3.7	10.50	4.7							
314.1	42	3.8	9.11	4.5							
389.4	34	3.5	7.34	4.3							
45.9	299	0.9	30.91	6.6	A302 - 90L/4A F302 - 90L/4A	29	81				
50.9	270	1.0	27.92	6.6							
53.7	256	1.0	26.45	6.6							
60.5	227	1.1	23.49	6.6							
66.6	207	1.2	21.33	6.5							
73.6	187	1.3	19.29	6.4							
87.6	157	1.6	16.21	6.2							
102.8	134	1.9	13.81	6.0							
118.3	116	2.2	12.00	5.8							
135.3	102	2.4	10.50	5.6							
155.9	88	2.4	9.11	5.4							
193.4	71	2.2	7.34	5.2							
254.4	54	3.0	5.58	4.8							
159.1	87	1.1	5.91	2.5	A351 - 100L/6A F351 - 100L/6A	31	83				
176.3	79	1.3	5.33	2.5							
194.0	72	1.3	4.85	2.5							
231.1	60	1.5	4.07	2.5							
250.7	55	1.6	3.75	2.5							
291.7	48	1.7	3.22	2.5							
358.9	39	1.8	2.62	2.4							
433.8	32	1.9	2.17	2.3							
647.6	21	2.8	1.45	2.0							
721.4	19	2.1	1.30	2.0							
336.5	40	1.9	8.50	2.5	A/F 351 - 80M/2C A/F 351 - 90S/2A	20	83				
384.4	35	2.1	7.44	2.4							
483.9	28	2.7	5.91	2.3							
536.6	25	3.0	5.33	2.2							
589.7	23	3.1	4.85	2.1							
703.3	19	3.5	4.07	2.0							
762.7	18	3.8	3.75	2.0							
887.6	15	4.0	3.22	1.7							
167.1	83	1.2	8.50	2.5	A351 - 90L/4A F351 - 90L/4A	24	83				
190.9	73	1.4	7.44	2.5							
240.3	58	1.7	5.91	2.5							
266.4	52	1.9	5.33	2.5							
292.8	47	2.0	4.85	2.5							
349.2	40	2.3	4.07	2.5							
378.7	37	2.5	3.75	2.4							
440.7	32	2.5	3.22	2.3							
542.2	26	2.7	2.62	2.2							
655.4	21	2.8	2.17	2.1							
1089.8	13	3.1	1.30	1.8							

P_1 [кВт]	n_2 [мин ⁻¹]	M_2 [Нм]	f_B	i	F_R [кН]	Редуктор		
1.50	29.4	468	1.0	32.01	8.0	A352 - 100L/6A F352 - 100L/6A	41	85
	32.5	423	1.2	28.89	8.0			
	35.4	389	1.3	26.59	8.0			
	37.4	368	1.3	25.13	8.0			
	42.7	322	1.5	22.03	8.0			
	46.3	297	1.5	20.31	8.0			
	51.4	268	1.7	18.30	8.0			
	55.7	247	1.8	16.88	8.0			
	64.8	212	2.0	14.52	8.0			
	80.1	172	2.3	11.74	8.0			
	96.4	143	2.6	9.75	8.0			
	107.7	128	2.7	8.73	7.8			
	133.2	103	2.8	7.06	7.4			
	160.3	86	3.0	5.86	7.0			
		50.2	262	1.4	56.95			
57.3		230	1.6	49.88	8.0			
62.1		212	1.7	46.04	8.0			
72.2		182	2.0	39.59	8.0			
85.4		154	2.4	33.50	8.0			
89.4		147	2.5	32.01	8.0			
99.0		133	2.8	28.89	8.0			
107.6		123	3.0	26.59	7.8			
113.8		116	3.0	25.13	7.7			
129.8		102	3.5	22.03	7.4			
140.8		94	3.7	20.31	7.3			
		28.5	483	1.0	49.88	8.0	A352 - 90L/4A F352 - 90L/4A	34
	30.8	446	1.1	46.04	8.0			
	35.9	383	1.3	39.59	8.0			
	42.4	324	1.5	33.50	8.0			
	44.4	310	1.6	32.01	8.0			
	49.2	280	1.8	28.89	8.0			
	53.4	258	1.9	26.59	8.0			
	56.5	243	1.9	25.13	8.0			
	64.5	213	2.2	22.03	8.0			
	69.9	197	2.3	20.31	8.0			
	77.6	177	2.6	18.30	8.0			
	84.1	163	2.8	16.88	8.0			
	97.8	141	3.1	14.52	8.0			
	121.0	114	3.4	11.74	7.5			
	145.6	94	3.9	9.75	7.2			
	39.4	327	1.1	72.58	8.0	A/F 353 - 80M/2C A/F 353 - 90S/2A	30	85
	48.7	265	1.4	58.68	8.0			
	113.9	122	1.4	8.25	3.7	A401 - 100L/6A F401 - 100L/6A	31	87
	130.2	107	1.6	7.22	3.7			
	164.1	85	2.0	5.73	3.7			
	181.9	76	2.2	5.17	3.7			
	200.3	69	2.3	4.69	3.7			
	239.0	58	2.6	3.93	3.7			
	259.3	54	2.8	3.63	3.7			
	302.1	46	2.8	3.11	3.7			
	372.5	37	3.2	2.52	3.7			
	451.2	31	3.9	2.08	3.4			
	346.7	39	3.3	8.25	3.7	A/F 401 - 80M/2C A/F 401 - 90S/2A	20	87
	396.0	34	3.7	7.22	3.6			
	172.1	81	2.1	8.25	3.7	A401 - 90L/4A F401 - 90L/4A	24	87
	196.6	71	2.4	7.22	3.7			
	247.9	56	3.0	5.73	3.7			
	274.8	51	3.4	5.17	3.7			
	302.6	46	3.5	4.69	3.7			
	361.0	38	3.9	3.93	3.7			



P_1 [кВт]	n_2 [мин ⁻¹]	M_2 [Нм]	f_B	i	F_R [кН]	Редуктор					
1.50	20.7	664	1.3	45.38	12.0	A402 - 100L/6A F402 - 100L/6A	52	89			
	23.7	581	1.5	39.72	12.0						
	25.8	533	1.5	36.44	12.0						
	29.8	461	1.8	31.50	12.0						
	32.5	423	1.9	28.89	12.0						
	37.2	370	2.3	25.30	12.0						
	41.0	335	2.5	22.91	12.0						
	47.1	292	2.9	19.94	12.0						
	54.1	254	3.3	17.37	12.0						
	58.7	234	3.4	16.01	12.0						
	64.8	212	3.3	14.50	12.0						
	75.5	182	3.8	12.44	12.0						
	82.0	168	3.9	11.46	12.0						
	63.0	209	3.0	45.38	12.0				A/F 402 - 80M/2C A/F 402 - 90S/2A	41	89
	72.0	183	3.5	39.72	12.0						
	78.5	168	3.6	36.44	12.0						
	31.3	439	1.9	45.38	12.0	A402 - 90L/4A F402 - 90L/4A	45	89			
	35.8	385	2.2	39.72	12.0						
	39.0	353	2.3	36.44	12.0						
	45.1	305	2.8	31.50	12.0						
	49.2	280	2.9	28.89	12.0						
	56.1	245	3.5	25.30	12.0						
	62.0	222	3.8	22.91	12.0						
	17.2	785	1.1	54.81	12.0	A403 - 100L/6A F403 - 100L/6A	52	89			
	18.9	711	1.2	49.64	12.0						
	21.1	610	1.0	135.37	12.0	A403 - 80M/2C F403 - 80M/2C	40	89			
	24.2	532	1.2	118.13	12.0	A/F 403 - 80M/2C A/F 403 - 90S/2A	41	89			
	30.2	428	1.5	94.86	12.0						
	33.3	387	1.6	85.91	12.0						
	15.0	900	0.9	94.86	12.0	A403 - 90L/4A F403 - 90L/4A	45	89			
	16.5	815	1.0	85.91	12.0						
	20.8	647	1.3	68.25	12.0						
	25.9	520	1.6	54.81	12.0						
	28.6	471	1.8	49.64	12.0						
	41.9	308	2.1	68.25	12.0	A403 - 90S/2A F403 - 90S/2A	41	89			
	52.2	247	2.6	54.81	12.0						
	57.6	224	2.8	49.64	12.0						
	109.9	126	2.8	8.56	4.0	A501 - 100L/6A F501 - 100L/6A	42	91			
	123.7	112	3.1	7.60	4.0						
	152.4	91	3.7	6.17	4.0						
	19.3	699	2.3	48.77	18.0	A502 - 100L/6A F502 - 100L/6A	69	93			
	21.7	621	2.6	43.32	18.0						
24.0	562	2.8	39.21	18.0							
27.0	499	3.2	34.83	18.0							
29.8	452	3.5	31.57	18.0							
33.3	405	4.0	28.26	18.0							
29.1	472	3.4	48.77	18.0	A502 - 90L/4A F502 - 90L/4A	62	93				
32.8	420	3.8	43.32	18.0							
7.6	1780	1.0	124.25	18.0	A503 - 100L/6A F503 - 100L/6A	69	93				
8.3	1613	1.1	112.61	18.0							
9.6	1401	1.3	97.80	18.0							
11.0	1222	1.5	85.33	18.0							
12.0	1127	1.6	78.64	18.0							
13.2	1021	1.8	71.27	18.0							
16.7	805	2.0	56.21	18.0							

P_1 [кВт]	n_2 [мин ⁻¹]	M_2 [Нм]	f_B	i	F_R [кН]	Редуктор		
1.50	12.8	1003	1.3	222.59	18.0	A/F 503 - 80M/2C A/F 503 - 90S/2A	58	93
	14.7	878	1.5	194.86	18.0			
	16.0	807	1.7	178.98	18.0			
	17.6	731	1.8	162.21	18.0			
	18.5	697	1.9	154.52	18.0			
	20.1	640	2.1	142.00	18.0			
	23.0	560	2.4	124.25	18.0			
	25.4	508	2.7	112.61	18.0			
	29.2	441	3.1	97.80	18.0			
	33.5	385	3.5	85.33	18.0			
36.4	355	3.8	78.64	18.0				
	7.3	1848	1.0	194.86	18.0	A503 - 90L/4A F503 - 90L/4A	62	93
	7.9	1697	1.1	178.98	18.0			
	8.8	1538	1.2	162.21	18.0			
	9.2	1465	1.2	154.52	18.0			
	10.0	1347	1.3	142.00	18.0			
	11.4	1178	1.5	124.25	18.0			
	12.6	1068	1.7	112.61	18.0			
	14.5	927	1.9	97.80	18.0			
	18.1	746	2.4	78.64	18.0			
	19.9	676	2.7	71.27	18.0			
25.3	533	3.0	56.21	18.0				
	3.9	3476	1.0	242.67	22.0	A603 - 100L/6A F603 - 100L/6A	97	97
	4.4	3088	1.1	215.56	22.0			
	4.8	2783	1.3	194.31	22.0			
	5.2	2595	1.3	181.13	22.0			
	5.8	2305	1.5	160.90	22.0			
	6.5	2057	1.7	143.57	22.0			
	7.0	1923	1.8	134.25	22.0			
	7.8	1734	2.0	121.02	22.0			
	9.4	1436	2.4	100.21	22.0			
	10.0	1341	2.6	93.60	22.0			
11.1	1209	2.9	84.37	22.0				
11.8	1146	3.1	79.98	22.0				
13.5	1001	3.5	69.87	22.0				
	5.9	2301	1.6	242.67	22.0	A603 - 90L/4A F603 - 90L/4A	90	97
	6.6	2044	1.7	215.56	22.0			
	7.3	1843	1.9	194.31	22.0			
	7.8	1718	2.0	181.13	22.0			
	8.8	1526	2.3	160.90	22.0			
9.9	1361	2.6	143.57	22.0				
	11.8	1094	2.5	242.67	22.0	A603 - 90S/2A F603 - 90S/2A	86	97
	13.3	972	2.7	215.56	22.0			
	14.7	876	3.0	194.31	22.0			
	15.8	817	3.2	181.13	22.0			
	17.8	725	3.6	160.90	22.0			
19.9	647	4.1	143.57	22.0				
	3.6	3727	1.3	260.15	30.0	A703 - 100L/6A F703 - 100L/6A	126	101
	4.1	3314	1.5	231.34	30.0			
	4.5	2976	1.7	207.78	30.0			
	5.0	2715	1.8	189.54	30.0			
	5.4	2480	2.0	173.11	30.0			
	6.0	2227	2.2	155.48	30.0			
	6.5	2076	2.4	144.94	30.0			
	7.3	1839	2.7	128.35	30.0			
	7.9	1701	2.9	118.75	30.0			
	8.7	1554	3.2	108.46	30.0			
9.4	1438	3.5	100.38	30.0				
10.4	1289	3.9	89.95	30.0				



P_1 [кВт]	n_2 [мин ⁻¹]	M_2 [Нм]	f_B	i	F_R [кН]	Редуктор		
1.85	148.6	114	0.9	6.36	3.9	A252 - 100L/6 F252 - 100L/6	37	77
	196.9	86	1.1	4.80	3.7			
	76.3	222	0.9	18.49	4.0	A252 - 90L/4 F252 - 90L/4	26	77
	82.7	205	0.9	17.05	4.0			
	94.6	179	0.9	14.91	4.0			
	101.1	168	1.0	13.94	4.0			
	117.8	144	1.0	11.97	4.0			
	136.6	124	1.1	10.32	3.9			
	156.3	109	1.2	9.02	3.8			
	177.8	95	1.3	7.93	3.8			
	221.7	77	1.4	6.36	3.6			
	293.8	58	1.6	4.80	3.4			
	386.6	44	1.0	3.65	0.8	A301 - 90L/4 F301 - 90L/4	22	79
	446.5	38	1.0	3.16	0.8			
	510.5	34	0.9	2.76	0.8			
	544.2	31	1.0	2.59	0.8			
	691.7	25	1.0	2.04	0.7			
	960.0	18	1.4	1.47	0.7			
	68.4	248	1.0	13.81	6.0	A302 - 100L/6 F302 - 100L/6	40	81
	78.8	215	1.2	12.00	5.9			
	90.0	188	1.3	10.50	5.8			
	103.7	164	1.3	9.11	5.7			
	128.7	132	1.2	7.34	5.5			
	169.3	100	1.6	5.58	5.2			
	60.0	283	0.9	23.49	6.1			
	66.1	257	1.0	21.33	6.1			
	73.1	232	1.1	19.29	6.0			
	87.0	195	1.3	16.21	5.9			
	102.1	166	1.5	13.81	5.7			
	117.5	144	1.7	12.00	5.6			
	134.3	126	1.9	10.50	5.4			
	154.8	110	1.9	9.11	5.3			
	192.1	88	1.8	7.34	5.0			
	252.6	67	2.4	5.58	4.7			
	159.9	107	0.9	5.91	2.5	A351 - 100L/6 F351 - 100L/6	35	83
	177.3	97	1.0	5.33	2.5			
	194.8	88	1.1	4.85	2.5			
	232.2	74	1.2	4.07	2.5			
	252.0	68	1.3	3.75	2.5			
	293.5	58	1.4	3.22	2.5			
	360.8	47	1.5	2.62	2.4			
	436.2	39	1.5	2.17	2.3			
	651.0	26	2.3	1.45	2.0			
	725.2	24	1.7	1.30	2.0			
	165.9	103	1.0	8.50	2.5	A351 - 90L/4 F351 - 90L/4	24	83
	189.5	90	1.1	7.44	2.5			
	238.6	72	1.4	5.91	2.5			
	264.5	65	1.5	5.33	2.5			
290.7	59	1.6	4.85	2.5				
346.4	49	1.8	4.07	2.4				
376.0	46	2.0	3.75	2.4				
437.9	39	2.0	3.22	2.3				
538.4	32	2.2	2.62	2.1				
650.8	26	2.3	2.17	2.0				
971.3	18	3.4	1.45	1.8				
1082.1	16	2.5	1.30	1.8				
32.7	519	0.9	28.89	8.0	A352 - 100L/6 F352 - 100L/6			
35.5	477	1.0	26.59	8.0				
37.6	451	1.0	25.13	8.0				
42.9	395	1.2	22.03	8.0				
46.5	365	1.3	20.31	8.0				
51.6	328	1.4	18.30	8.0				
56.0	303	1.5	16.88	8.0				
65.1	261	1.7	14.52	8.0				
80.5	211	1.9	11.74	8.0				
96.9	175	2.1	9.75	7.8				
108.2	157	2.2	8.73	7.6				
133.9	127	2.3	7.06	7.2				
161.2	105	2.5	5.86	6.9				

P_1 [кВт]	n_2 [мин ⁻¹]	M_2 [Нм]	f_B	i	F_R [кН]	Редуктор		
1.85	35.6	476	1.0	39.59	8.0	A352 - 90L/4 F352 - 90L/4	34	85
	42.1	403	1.2	33.50	8.0			
	44.0	385	1.3	32.01	8.0			
	48.8	348	1.4	28.89	8.0			
	53.0	320	1.5	26.59	8.0			
	56.1	302	1.6	25.13	8.0			
	64.0	265	1.8	22.03	8.0			
	69.4	244	1.9	20.31	8.0			
	77.0	220	2.1	18.30	8.0			
	83.6	203	2.2	16.88	8.0			
	97.1	175	2.5	14.52	7.7			
	120.1	141	2.8	11.74	7.4			
	144.6	117	3.2	9.75	7.0			
	161.5	105	3.2	8.73	6.8			
	199.8	85	3.4	7.06	6.4			
240.5	71	3.7	5.86	6.1				
	114.5	150	1.1	8.25	3.7	A401 - 100L/6 F401 - 100L/6	35	87
	130.8	131	1.3	7.22	3.7			
	165.0	104	1.6	5.73	3.7			
	182.9	94	1.8	5.17	3.7			
	201.4	85	1.9	4.69	3.7			
	240.3	71	2.1	3.93	3.7			
	260.7	66	2.3	3.63	3.7			
	303.8	56	2.3	3.11	3.7			
	374.4	46	2.6	2.52	3.6			
	453.6	38	3.2	2.08	3.4			
	720.0	24	3.4	1.31	2.9			
	170.9	100	1.7	8.25	3.7	A401 - 90L/4 F401 - 90L/4	24	87
	195.3	88	1.9	7.22	3.7			
	246.2	70	2.4	5.73	3.7			
	272.9	63	2.7	5.17	3.7			
	300.5	57	2.8	4.69	3.7			
	358.5	48	3.1	3.93	3.7			
	389.0	44	3.4	3.63	3.6			
	453.2	38	3.4	3.11	3.4			
	558.7	31	3.9	2.52	3.1			
	20.8	814	1.0	45.38	12.0			
	23.8	713	1.2	39.72	12.0			
	25.9	654	1.2	36.44	12.0			
	30.0	565	1.5	31.50	12.0			
	32.7	518	1.5	28.89	12.0			
	37.4	454	1.9	25.30	12.0			
	41.3	411	2.1	22.91	12.0			
	47.4	358	2.4	19.94	12.0			
	54.4	312	2.7	17.37	12.0			
	59.0	287	2.8	16.01	12.0			
	65.2	260	2.7	14.50	12.0			
	75.9	223	3.1	12.44	12.0			
	82.5	206	3.2	11.46	12.0			
	102.7	165	3.6	9.20	12.0			
	113.4	150	4.0	8.33	12.0			
	31.1	546	1.6	45.38	12.0	A402 - 90L/4 F402 - 90L/4	45	89
	35.5	478	1.8	39.72	12.0			
	38.7	438	1.8	36.44	12.0			
	44.8	379	2.2	31.50	12.0			
	48.8	348	2.3	28.89	12.0			
	55.7	304	2.8	25.30	12.0			
	61.5	276	3.1	22.91	12.0			
	70.7	240	3.5	19.94	12.0			
	81.2	209	4.0	17.37	12.0			
	97.2	174	4.0	14.50	12.0			
	28.4	585	1.5	49.64	12.0	A403 - 100L/6 F403 - 100L/6	56	89
	20.7	804	1.1	68.25	12.0	A403 - 90L/4 F403 - 90L/4	45	89
	25.7	646	1.3	54.81	12.0			
	28.4	585	1.5	49.64	12.0			

P_1 [кВт]	n_2 [мин ⁻¹]	M_2 [Нм]	f_B	i	F_R [кН]	Редуктор		
1.85	110.5	154	2.3	8.56	4.0	A501 - 100L/6 F501 - 100L/6	46	91
	124.3	136	2.6	7.60	4.0			
	153.2	111	3.1	6.17	4.0			
	168.3	101	3.3	5.62	4.0			
	199.6	85	3.8	4.73	4.0			
	164.8	104	3.4	8.56	4.0	A501 - 90L/4 F501 - 90L/4	35	91
	185.5	92	3.8	7.60	4.0			
	19.4	875	1.8	48.77	18.0	A502 - 100L/6 F502 - 100L/6	73	93
	21.8	778	2.1	43.32	18.0			
	24.1	704	2.3	39.21	18.0			
	27.1	625	2.6	34.83	18.0			
	29.9	567	2.8	31.57	18.0			
	33.4	507	3.2	28.26	18.0			
	35.0	484	3.3	26.98	18.0			
	40.8	415	3.9	23.14	18.0			
	28.9	587	2.7	48.77	18.0	A502 - 90L/4 F502 - 90L/4	62	93
	32.5	521	3.1	43.32	18.0			
	36.0	472	3.4	39.21	18.0			
	40.5	419	3.8	34.83	18.0			
	9.7	1719	1.0	97.80	18.0	A503 - 100L/6 F503 - 100L/6	73	93
	11.1	1500	1.2	85.33	18.0			
	12.0	1382	1.3	78.64	18.0			
	13.3	1253	1.4	71.27	18.0			
	16.8	988	1.6	56.21	18.0			
	8.7	1911	0.9	162.21	18.0	A503 - 90L/4 F503 - 90L/4	62	93
	9.1	1820	1.0	154.52	18.0			
	9.9	1673	1.1	142.00	18.0			
	11.3	1463	1.2	124.25	18.0			
	12.5	1326	1.4	112.61	18.0			
	14.4	1152	1.6	97.80	18.0			
	16.5	1005	1.8	85.33	18.0			
	17.9	926	1.9	78.64	18.0			
	19.8	839	2.1	71.27	18.0			
	25.1	662	2.4	56.21	18.0			
	18.6	914	3.6	50.91	22.0	A602 - 100L/6 F602 - 100L/6	101	97
	20.9	813	4.1	45.27	22.0			
	4.4	3788	0.9	215.56	22.0	A603 - 100L/6 F603 - 100L/6	101	97
	4.9	3415	1.0	194.31	22.0			
	5.2	3183	1.1	181.13	22.0			
	5.9	2828	1.2	160.90	22.0			
	6.6	2523	1.4	143.57	22.0			
	7.0	2359	1.5	134.25	22.0			
7.8	2127	1.6	121.02	22.0				
9.4	1761	2.0	100.21	22.0				
10.1	1645	2.1	93.60	22.0				
11.2	1483	2.4	84.37	22.0				
11.8	1406	2.5	79.98	22.0				
13.5	1228	2.9	69.87	22.0				
5.8	2858	1.3	242.67	22.0	A603 - 90L/4 F603 - 90L/4			
6.5	2539	1.4	215.56	22.0				
7.3	2289	1.5	194.31	22.0				
7.8	2133	1.6	181.13	22.0				
8.8	1895	1.8	160.90	22.0				
9.8	1691	2.1	143.57	22.0				
3.6	4572	1.1	260.15	30.0	A703 - 100L/6 F703 - 100L/6	131	101	
4.1	4066	1.2	231.34	30.0				
4.5	3652	1.4	207.78	30.0				
5.0	3331	1.5	189.54	30.0				
5.5	3042	1.6	173.11	30.0				
6.1	2732	1.8	155.48	30.0				
6.5	2547	2.0	144.94	30.0				
7.4	2256	2.2	128.35	30.0				
8.0	2087	2.4	118.75	30.0				
8.7	1906	2.6	108.46	30.0				
9.4	1764	2.8	100.38	30.0				
10.5	1581	3.2	89.95	30.0				
11.3	1465	3.4	83.35	30.0				
12.8	1295	3.9	73.70	30.0				

P_1 [кВт]	n_2 [мин ⁻¹]	M_2 [Нм]	f_B	i	F_R [кН]	Редуктор					
2.20	136.7	148	0.9	10.32	3.6	A252 - 100L/4A F252 - 100L/4A	34	77			
	156.3	129	1.0	9.02	3.6						
	177.8	113	1.1	7.93	3.6						
	221.7	91	1.2	6.36	3.5						
	293.8	69	1.4	4.80	3.3						
	141.6	136	1.1	20.19	3.7				A252 - 90L/2A F252 - 90L/2A	27	77
	154.7	125	1.2	18.49	3.7						
	167.7	115	1.2	17.05	3.6						
	191.8	101	1.3	14.91	3.6						
	205.2	94	1.4	13.94	3.6						
239.0	81	1.3	11.97	3.5							
277.2	70	1.5	10.32	3.4							
317.0	61	1.6	9.02	3.3							
360.6	54	1.7	7.93	3.2							
449.4	43	1.8	6.36	3.1							
596.1	32	2.2	4.80	2.9							
670.3	29	1.1	4.27	0.7	A301 - 90L/2A F301 - 90L/2A	30	79				
784.2	25	1.3	3.65	0.7							
905.7	22	1.4	3.16	0.7							
1035.5	19	1.2	2.76	0.6							
1103.9	18	1.3	2.59	0.6							
1403.0	14	1.3	2.04	0.6							
1947.2	10	1.8	1.47	0.6							
73.1	276	0.9	19.29	5.6	A302 - 100L/4A F302 - 100L/4A	37	81				
87.0	232	1.1	16.21	5.6							
102.1	198	1.3	13.81	5.5							
117.5	172	1.5	12.00	5.3							
134.3	150	1.6	10.50	5.2							
154.8	130	1.6	9.11	5.1							
192.1	105	1.5	7.34	4.9							
252.7	80	2.0	5.58	4.6							
169.3	119	1.3	5.58	5.0	A302 - 112M/6A F302 - 112M/6A	45	81				
102.4	189	1.1	27.92	5.5	A302 - 90L/2A F302 - 90L/2A	30	81				
108.1	179	1.1	26.45	5.5							
121.7	159	1.2	23.49	5.4							
134.1	144	1.3	21.33	5.3							
148.2	130	1.4	19.29	5.2							
176.4	110	1.7	16.21	5.0							
207.1	93	2.0	13.81	4.8							
238.3	81	2.3	12.00	4.7							
272.5	71	2.5	10.50	4.5							
314.1	62	2.6	9.11	4.4							
389.4	50	2.4	7.34	4.1							
512.4	38	3.2	5.58	3.9							
238.6	85	1.2	5.91	2.5				A351 - 100L/4A F351 - 100L/4A	32	83	
264.5	77	1.3	5.33	2.5							
290.7	70	1.4	4.85	2.4							
346.4	59	1.5	4.07	2.3							
376.0	54	1.7	3.75	2.3							
437.9	47	1.7	3.22	2.2							
538.2	38	1.8	2.62	2.1							
649.8	31	1.9	2.17	2.0							
972.4	21	2.9	1.45	1.8							
1084.6	19	2.1	1.30	1.7							
252.0	81	1.1	3.75	2.5	A351 - 112M/6A F351 - 112M/6A	40	83				
293.3	69	1.2	3.22	2.4							
360.8	56	1.2	2.62	2.3							
436.2	47	1.3	2.17	2.2							
651.0	31	1.9	1.45	2.0							
725.2	28	1.4	1.30	1.9							



P_1 [кВт]	n_2 [мин ⁻¹]	M_2 [Нм]	f_B	i	F_R [кН]	Редуктор		
2.20	336.5	59	1.3	8.50	2.4	A351 - 90L/2A F351 - 90L/2A	25	83
	384.2	51	1.5	7.44	2.3			
	484.0	41	1.8	5.91	2.2			
	536.3	37	2.0	5.33	2.1			
	590.2	33	2.1	4.85	2.1			
	703.3	28	2.4	4.07	2.0			
	762.7	26	2.6	3.75	1.9			
	887.6	22	2.7	3.22	1.8			
	1092.0	18	2.9	2.62	1.7			
	1320.0	15	3.0	2.17	1.6			
2194.9	9	3.3	1.30	1.4				
	44.0	458	1.1	32.01	8.0	A352 - 100L/4A F352 - 100L/4A	42	85
	48.8	413	1.2	28.89	8.0			
	53.0	380	1.3	26.59	8.0			
	56.1	359	1.3	25.13	8.0			
	64.0	315	1.5	22.03	8.0			
	69.4	291	1.6	20.31	8.0			
	77.0	262	1.8	18.30	7.9			
	83.5	241	1.9	16.88	7.8			
	97.1	208	2.1	14.52	7.5			
	120.1	168	2.3	11.74	7.2			
	144.6	139	2.7	9.75	6.9			
	161.5	125	2.7	8.73	6.7			
	199.8	101	2.9	7.06	6.3			
	240.5	84	3.1	5.86	6.0			
	51.6	391	1.2	18.30	8.0	A352 - 112M/6A F352 - 112M/6A	50	85
	56.0	360	1.2	16.88	8.0			
	65.1	310	1.4	14.52	8.0			
	80.5	250	1.6	11.74	7.8			
	96.9	208	1.8	9.75	7.6			
	108.2	186	1.8	8.73	7.4			
	133.9	151	1.9	7.06	7.1			
	161.2	125	2.1	5.86	6.7			
	57.3	337	1.1	49.88	8.0	A352 - 90L/2A F352 - 90L/2A	35	85
	62.1	311	1.2	46.04	8.0			
	72.2	268	1.4	39.59	8.0			
	85.4	226	1.6	33.50	7.8			
	89.4	216	1.7	32.01	7.7			
	99.0	195	1.9	28.89	7.6			
	107.6	180	2.0	26.59	7.4			
	113.8	170	2.1	25.13	7.3			
	129.8	149	2.4	22.03	7.1			
	140.8	137	2.5	20.31	7.0			
	156.3	124	2.8	18.30	6.8			
	169.5	114	3.0	16.88	6.7			
	197.0	98	3.3	14.52	6.4			
	243.7	79	3.7	11.74	6.1			
	170.9	119	1.4	8.25	3.7	A401 - 100L/4A F401 - 100L/4A	32	87
	195.3	104	1.6	7.22	3.7			
	246.1	83	2.1	5.73	3.7			
	272.7	75	2.3	5.17	3.7			
	300.6	68	2.4	4.69	3.7			
	358.5	57	2.6	3.93	3.6			
	389.0	52	2.9	3.63	3.5			
	453.2	45	2.9	3.11	3.4			
	558.7	36	3.3	2.52	3.2			
	676.8	30	4.0	2.08	2.9			
	165.0	124	1.4	5.73	3.7	A401 - 112M/6A F401 - 112M/6A	40	87
	182.9	111	1.5	5.17	3.7			
	201.4	101	1.6	4.69	3.7			
	240.3	85	1.8	3.93	3.7			
	260.7	78	1.9	3.63	3.7			
	303.8	67	1.9	3.11	3.7			
	374.4	54	2.2	2.52	3.6			
	453.6	45	2.7	2.08	3.4			
	720.0	28	2.8	1.31	3.0			

P_1 [кВт]	n_2 [мин ⁻¹]	M_2 [Нм]	f_B	i	F_R [кН]	Редуктор		
2.20	346.7	57	2.2	8.25	3.7	A401 - 90L/2A F401 - 90L/2A	25	87
	396.0	50	2.6	7.22	3.5			
	499.4	40	3.2	5.73	3.3			
	553.5	36	3.6	5.17	3.2			
	609.5	32	3.7	4.69	3.1			
	31.1	649	1.3	45.38	12.0	A402 - 100L/4A F402 - 100L/4A	53	89
	35.5	568	1.5	39.72	12.0			
	38.7	521	1.5	36.44	12.0			
	44.8	451	1.9	31.50	12.0			
	48.8	413	1.9	28.89	12.0			
	55.7	362	2.3	25.30	12.0			
	61.5	328	2.6	22.91	12.0			
	70.7	285	3.0	19.94	12.0			
	81.2	249	3.3	17.37	12.0			
	88.1	229	3.5	16.01	12.0			
	97.2	207	3.4	14.50	12.0			
	113.3	178	3.9	12.44	12.0			
	123.1	164	4.0	11.46	12.0			
	30.0	672	1.3	31.50	12.0	A402 - 112M/6A F402 - 112M/6A	56	89
	32.7	617	1.3	28.89	12.0			
	37.4	540	1.6	25.30	12.0			
	41.3	489	1.7	22.91	12.0			
	47.4	426	2.0	19.94	12.0			
	54.4	371	2.2	17.37	12.0			
	59.0	342	2.3	16.01	12.0			
	65.2	309	2.3	14.50	12.0			
	75.9	266	2.6	12.44	12.0			
	82.5	245	2.7	11.46	12.0			
	102.7	196	3.1	9.20	12.0			
	113.4	178	3.4	8.33	12.0			
	130.9	154	3.6	7.22	12.0			
	63.0	307	2.1	45.38	12.0	A402 - 90L/2A F402 - 90L/2A	46	89
	72.0	268	2.4	39.72	12.0			
	78.5	246	2.4	36.44	12.0			
	90.8	213	3.0	31.50	12.0			
	99.0	195	3.1	28.89	12.0			
113.1	171	3.7	25.30	12.0				
124.8	155	4.1	22.91	12.0				
25.7	768	1.1	54.81	12.0	A403 - 100L/4A F403 - 100L/4A	53	89	
28.4	695	1.2	49.64	12.0				
33.3	568	1.1	85.91	12.0	A403 - 90L/2A F403 - 90L/2A	46	89	
41.9	451	1.4	68.25	12.0				
52.2	362	1.8	54.81	12.0				
57.6	328	1.9	49.64	12.0				
164.8	124	2.8	8.56	4.0	A501 - 100L/4A F501 - 100L/4A	43	91	
185.5	110	3.2	7.60	4.0				
228.6	89	3.8	6.17	4.0				
110.5	185	1.9	8.56	4.0	A501 - 112M/6A F501 - 112M/6A	51	91	
124.3	164	2.1	7.60	4.0				
153.2	133	2.6	6.17	4.0				
168.3	121	2.7	5.62	4.0				
199.6	102	3.1	4.73	4.0				
232.8	88	3.7	4.06	4.0				
250.1	81	3.8	3.78	4.0				
28.9	698	2.3	48.77	18.0				A502 - 100L/4A F502 - 100L/4A
32.5	620	2.6	43.32	18.0				
36.0	561	2.9	39.21	18.0				
40.5	498	3.2	34.83	18.0				
44.7	452	3.5	31.57	18.0				
49.9	404	4.0	28.26	18.0				



P_1 [кВт]	n_2 [мин ⁻¹]	M_2 [Нм]	f_B	i	F_R [кН]	Редуктор		
2.20	19.4	1041	1.5	48.77	18.0	A502 - 112M/6A F502 - 112M/6A	78	93
	21.8	925	1.7	43.32	18.0			
	24.1	837	1.9	39.21	18.0			
	27.1	743	2.2	34.83	18.0			
	29.9	674	2.4	31.57	18.0			
	33.4	603	2.7	28.26	18.0			
	35.0	576	2.8	26.98	18.0			
	40.8	494	3.2	23.14	18.0			
	43.6	463	3.5	21.69	18.0			
	48.1	420	3.8	19.66	18.0			
	50.2	401	3.7	18.81	18.0			
	58.6	330	3.6	48.77	18.0			
	11.3	1740	1.0	124.25	18.0	A503 - 100L/4A F503 - 100L/4A	70	93
	12.5	1577	1.1	112.61	18.0			
	14.4	1370	1.3	97.80	18.0			
	16.5	1195	1.5	85.33	18.0			
	17.9	1101	1.6	78.64	18.0			
	19.8	998	1.8	71.27	18.0			
	25.1	787	2.0	56.21	18.0			
	13.3	1490	1.2	71.27	18.0	A503 - 112M/6A F503 - 112M/6A	78	93
	16.8	1175	1.4	56.21	18.0			
	14.7	1288	1.0	194.86	18.0	A503 - 90L/2A F503 - 90L/2A	63	93
	16.0	1183	1.1	178.98	18.0			
	17.6	1072	1.3	162.21	18.0			
	18.5	1022	1.3	154.52	18.0			
	20.1	939	1.4	142.00	18.0			
	23.0	821	1.6	124.25	18.0			
	25.4	745	1.8	112.61	18.0			
	29.2	647	2.1	97.80	18.0			
	33.5	564	2.4	85.33	18.0			
	36.4	520	2.6	78.64	18.0			
	40.1	471	2.9	71.27	18.0			
	50.9	372	3.2	56.21	18.0			
	113.9	179	3.6	8.30	5.0			
	126.8	161	4.0	7.45	5.0			
	18.6	1087	3.0	50.91	22.0	A602 - 112M/6A F602 - 112M/6A	106	97
	20.9	966	3.4	45.27	22.0			
	23.2	871	3.8	40.81	22.0			
	24.9	811	3.5	38.00	22.0			
	5.8	3399	1.1	242.67	22.0	A603 - 100L/4A F603 - 100L/4A	98	97
	6.5	3019	1.2	215.56	22.0			
	7.3	2722	1.3	194.31	22.0			
7.8	2537	1.4	181.13	22.0				
8.8	2254	1.6	160.90	22.0				
9.8	2011	1.7	143.57	22.0				
10.5	1880	1.9	134.25	22.0				
11.7	1695	2.1	121.02	22.0				
14.1	1404	2.5	100.21	22.0				
15.1	1311	2.7	93.60	22.0				
16.7	1182	3.0	84.37	22.0				
17.6	1120	3.1	79.98	22.0				
20.2	979	3.6	69.87	22.0				
6.6	3000	1.2	143.57	22.0	A603 - 112M/6A F603 - 112M/6A	106	97	
7.0	2806	1.2	134.25	22.0				
7.8	2529	1.4	121.02	22.0				
9.4	2094	1.7	100.21	22.0				
10.1	1956	1.8	93.60	22.0				
11.2	1763	2.0	84.37	22.0				
11.8	1672	2.1	79.98	22.0				
13.5	1460	2.4	69.87	22.0				
11.8	1604	1.7	242.67	22.0	A603 - 90L/2A F603 - 90L/2A	91	97	
13.3	1425	1.8	215.56	22.0				
14.7	1285	2.0	194.31	22.0				
15.8	1198	2.2	181.13	22.0				
17.8	1064	2.5	160.90	22.0				
19.9	949	2.8	143.57	22.0				

P_1 [кВт]	n_2 [мин ⁻¹]	M_2 [Нм]	f_B	i	F_R [кН]	Редуктор		
2.20	5.4	3644	1.4	260.15	30.0	A703 - 100L/4A F703 - 100L/4A	128	101
	6.1	3240	1.5	231.34	30.0			
	6.8	2910	1.7	207.78	30.0			
	7.4	2655	1.9	189.54	30.0			
	8.1	2425	2.1	173.11	30.0			
	9.1	2178	2.3	155.48	30.0			
	9.7	2030	2.5	144.94	30.0			
	11.0	1798	2.8	128.35	30.0			
	11.9	1663	3.0	118.75	30.0			
	13.0	1519	3.3	108.46	30.0			
	14.0	1406	3.6	100.38	30.0			
	15.7	1260	4.0	89.95	30.0			
	4.5	4342	1.2	207.78	30.0	A703 - 112M/6A F703 - 112M/6A	135	101
	5.0	3961	1.3	189.54	30.0			
	5.5	3618	1.4	173.11	30.0			
	6.1	3249	1.5	155.48	30.0			
	6.5	3029	1.7	144.94	30.0			
	7.4	2682	1.9	128.35	30.0			
	8.0	2482	2.0	118.75	30.0			
	8.7	2267	2.2	108.46	30.0			
9.4	2098	2.4	100.38	30.0				
10.5	1880	2.7	89.95	30.0				
11.3	1742	2.9	83.35	30.0				
12.8	1540	3.2	73.70	30.0				
14.0	1407	3.6	67.31	30.0				
3.00	280.2	94	1.1	10.32	3.1	A252 - 100L/2A F252 - 100L/2A	34	77
	320.3	82	1.2	9.02	3.1			
	364.4	72	1.3	7.93	3.0			
	454.1	58	1.4	6.36	2.9			
	602.3	44	1.6	4.80	2.7			
	293.8	94	1.0	4.80	3.1	A252 - 100L/4B F252 - 100L/4B	37	77
	149.8	176	1.1	19.29	4.8	A302 - 100L/2A F302 - 100L/2A	37	81
	178.2	148	1.3	16.21	4.7			
	209.3	126	1.5	13.81	4.6			
	240.8	109	1.7	12.00	4.4			
	275.4	96	1.9	10.50	4.3			
	317.4	83	1.9	9.11	4.2			
	393.5	67	1.8	7.34	4.0			
	517.8	51	2.4	5.58	3.7			
	102.1	269	0.9	13.81	4.9	A302 - 100L/4B F302 - 100L/4B	40	81
	117.5	234	1.1	12.00	4.8			
	134.3	205	1.2	10.50	4.8			
	154.8	178	1.2	9.11	4.7			
	192.1	143	1.1	7.34	4.6			
	252.7	109	1.5	5.58	4.3			
171.1	161	1.0	5.58	4.7	A302 - 132S/6B F302 - 132S/6B	61	81	
489.1	55	1.4	5.91	2.1	A351 - 100L/2A F351 - 100L/2A	32	83	
542.2	50	1.5	5.33	2.0				
595.9	45	1.6	4.85	2.0				
710.1	38	1.8	4.07	1.9				
770.7	35	1.9	3.75	1.9				
897.5	30	2.0	3.22	1.8				
1103.1	24	2.2	2.62	1.7				
1331.8	20	2.2	2.17	1.6				
1993.1	14	3.3	1.45	1.4				
2223.1	12	2.5	1.30	1.4				
264.5	105	1.0	5.33	2.3	A351 - 100L/4B F351 - 100L/4B	35	83	
290.7	96	1.0	4.85	2.3				
346.4	80	1.1	4.07	2.2				
376.0	74	1.2	3.75	2.2				
437.9	63	1.3	3.22	2.1				
538.2	52	1.4	2.62	2.0				
649.8	43	1.4	2.17	1.9				
972.4	29	2.1	1.45	1.7				
1084.6	26	1.6	1.30	1.7				



P_1 [кВт]	n_2 [мин ⁻¹]	M_2 [Нм]	f_B	i	F_R [кН]	Редуктор		
3.00	364.6	76	0.9	2.62	2.2	A351 - 112M/6 F351 - 112M/6	42	83
	440.8	63	1.0	2.17	2.1			
	657.9	42	1.4	1.45	1.9			
	732.9	38	1.1	1.30	1.9			
	90.3	292	1.3	32.01	7.2	A352 - 100L/2A F352 - 100L/2A	42	85
	100.0	263	1.4	28.89	7.1			
	108.7	243	1.5	26.59	7.0			
	115.0	229	1.5	25.13	6.9			
	131.2	201	1.8	22.03	6.8			
	142.3	185	1.9	20.31	6.6			
157.9	167	2.1	18.30	6.5				
171.3	154	2.2	16.88	6.4				
199.1	132	2.4	14.52	6.2				
246.2	107	2.7	11.74	5.9				
296.4	89	3.1	9.75	5.6				
331.0	80	3.2	8.73	5.4				
409.5	64	3.4	7.06	5.1				
492.9	53	3.6	5.86	4.9				
53.0	519	0.9	26.59	7.4	A352 - 100L/4B F352 - 100L/4B	45	85	
56.1	490	1.0	25.13	7.4				
64.0	430	1.1	22.03	7.4				
69.4	396	1.2	20.31	7.3				
77.0	357	1.3	18.30	7.2				
83.5	329	1.4	16.88	7.2				
97.1	283	1.5	14.52	7.0				
120.1	229	1.7	11.74	6.8				
144.6	190	1.9	9.75	6.5				
161.5	170	2.0	8.73	6.4				
199.7	138	2.1	7.06	6.1				
240.6	114	2.3	5.86	5.8				
56.6	486	0.9	16.88	7.4	A352 - 112M/6 F352 - 112M/6	52	85	
65.8	418	1.0	14.52	7.3				
81.3	338	1.2	11.74	7.2				
97.9	281	1.3	9.75	7.0				
109.4	251	1.4	8.73	6.9				
135.3	203	1.4	7.06	6.7				
163.0	169	1.5	5.86	6.4				
350.3	77	1.7	8.25	3.6	A401 - 100L/2A F401 - 100L/2A	32	87	
400.3	67	1.9	7.22	3.4				
504.4	53	2.4	5.73	3.2				
559.0	48	2.6	5.17	3.1				
616.2	44	2.7	4.69	3.0				
735.4	37	3.1	3.93	2.9				
798.3	34	3.3	3.62	2.8				
929.3	29	3.4	3.11	2.7				
1146.8	23	3.8	2.52	2.5				
170.9	163	1.0	8.25	3.7				A401 - 100L/4B F401 - 100L/4B
195.3	142	1.2	7.22	3.7				
246.1	113	1.5	5.73	3.7				
272.7	102	1.7	5.17	3.7				
300.6	92	1.7	4.69	3.7				
358.8	77	1.9	3.93	3.5				
389.5	71	2.1	3.62	3.4				
453.4	61	2.1	3.11	3.3				
559.5	50	2.4	2.52	3.1				
676.8	41	2.9	2.08	2.9				
1074.3	26	3.1	1.31	2.6				
166.7	167	1.0	5.73	3.7	A401 - 112M/6 F401 - 112M/6	41	87	
184.8	150	1.1	5.17	3.7				
203.5	137	1.2	4.69	3.7				
242.8	114	1.3	3.93	3.7				
263.4	105	1.4	3.63	3.7				
307.0	91	1.4	3.11	3.7				
378.4	73	1.6	2.52	3.6				
458.4	61	2.0	2.08	3.3				
727.6	38	2.1	1.31	3.0				

P_1 [кВт]	n_2 [мин ⁻¹]	M_2 [Нм]	f_B	i	F_R [кН]	Редуктор						
3.00	63.7	414	1.5	45.38	12.0	A402 - 100L/2A F402 - 100L/2A	53	89				
	72.8	362	1.8	39.72	12.0							
	79.3	332	1.8	36.44	12.0							
	91.7	287	2.2	31.50	12.0							
	100.0	263	2.3	28.89	12.0							
	114.2	231	2.8	25.30	12.0							
	126.1	209	3.1	22.91	12.0							
	144.9	182	3.5	19.94	12.0							
	166.4	158	3.9	17.37	11.7							
	180.5	146	4.1	16.01	11.4							
	199.3	132	4.0	14.50	11.1							
		31.1	885	1.0	45.38				12.0	A402 - 100L/4B F402 - 100L/4B	56	89
		35.5	775	1.1	39.72				12.0			
		38.7	711	1.1	36.44				12.0			
44.8		614	1.4	31.50	12.0							
48.8		564	1.4	28.89	12.0							
55.7		494	1.7	25.30	12.0							
61.5		447	1.9	22.91	12.0							
70.7		389	2.2	19.94	12.0							
81.2		339	2.4	17.37	12.0							
88.1		312	2.6	16.01	12.0							
97.2		283	2.5	14.50	12.0							
113.3		243	2.9	12.44	12.0							
123.1		224	2.9	11.46	12.0							
153.2		179	3.3	9.20	11.8							
169.2	163	3.7	8.33	11.5								
195.3	141	3.9	7.22	11.1								
	30.3	907	0.9	31.50	12.0	A402 - 112M/6 F402 - 112M/6	62	89				
	33.1	832	1.0	28.89	12.0							
	37.8	729	1.2	25.30	12.0	A/F 402 - 112M/6 A/F 402 - 132S/6B	76	89				
	41.7	660	1.3	22.91	12.0							
	47.9	574	1.5	19.94	12.0							
	55.0	500	1.7	17.37	12.0							
	59.6	461	1.7	16.01	12.0							
	65.9	418	1.7	14.50	12.0							
	76.7	358	2.0	12.44	12.0							
	83.3	330	2.0	11.46	12.0							
	103.8	265	2.3	9.20	12.0							
	114.6	240	2.5	8.33	12.0							
	132.3	208	2.6	7.22	12.0							
	164.7	167	3.3	5.80	11.8							
	181.9	151	3.3	5.25	11.5							
		52.7	489	1.3	54.81				12.0	A403 - 100L/2A F403 - 100L/2A	53	89
58.2		443	1.4	49.64	12.0							
	337.6	80	3.3	8.56	4.0	A501 - 100L/2A F501 - 100L/2A	43	91				
	380.3	71	3.7	7.60	4.0							
	164.7	169	2.1	8.56	4.0	A501 - 100L/4B F501 - 100L/4B	46	91				
	185.5	150	2.3	7.60	4.0							
	228.6	122	2.8	6.17	4.0							
	251.1	111	3.0	5.62	4.0							
	297.9	93	3.4	4.73	4.0							
	111.6	249	1.4	8.56	4.0	A/F 501 - 112M/6 A/F 501 - 132S/6B	66	91				
	125.7	221	1.6	7.60	4.0							
	154.9	179	1.9	6.17	4.0							
	170.1	163	2.0	5.62	4.0							
	201.8	138	2.3	4.73	4.0							
	235.3	118	2.7	4.06	4.0							
	252.8	110	2.8	3.78	4.0							
	289.4	96	3.2	3.30	4.0							
	369.7	75	3.7	2.58	4.0							
	59.3	445	2.7	48.77	18.0	A502 - 100L/2A F502 - 100L/2A	70	93				
	66.7	395	3.0	43.32	18.0							
	73.7	358	3.4	39.21	18.0							
	83.0	318	3.8	34.83	17.6							



P_1 [кВт]	n_2 [мин ⁻¹]	M_2 [Нм]	f_B	i	F_R [кН]	Редуктор					
3.00	28.9	951	1.7	48.77	18.0	A502 - 100L/4B F502 - 100L/4B	73	93			
	32.5	845	1.9	43.32	18.0						
	36.0	765	2.1	39.21	18.0						
	40.5	679	2.4	34.83	18.0						
	44.7	616	2.6	31.57	18.0						
	49.9	551	2.9	28.26	18.0						
	52.3	526	3.0	26.98	18.0						
	60.9	451	3.5	23.14	18.0						
	65.0	423	3.8	21.69	18.0						
	19.6	1404	1.1	48.77	18.0				A/F 502 - 112M/6 A/F 502 - 132S/6B	93	93
	22.0	1248	1.3	43.32	18.0						
	24.4	1129	1.4	39.21	18.0						
	27.4	1003	1.6	34.83	18.0						
	30.3	909	1.8	31.57	18.0						
	33.8	814	2.0	28.26	18.0						
	35.4	777	2.1	26.98	18.0						
	41.3	666	2.4	23.14	18.0						
	44.0	625	2.6	21.69	18.0						
	48.6	566	2.8	19.66	18.0						
	50.8	542	2.8	18.81	18.0						
	56.6	486	3.1	16.86	18.0						
	63.1	436	3.4	15.13	18.0						
	69.7	395	3.5	13.71	18.0						
	85.2	323	3.4	11.20	17.5	A502 - 132S/6B F502 - 132S/6B	93	93			
	106.0	259	3.5	9.01	16.5						
	117.0	235	3.4	8.16	16.1						
	126.5	217	3.7	7.55	15.7						
	23.3	1109	1.2	124.25	18.0	A503 - 100L/2A F503 - 100L/2A	70	93			
	25.7	1005	1.3	112.61	18.0						
	29.5	873	1.5	97.80	18.0						
	33.9	761	1.8	85.33	18.0						
	36.7	702	1.9	78.64	18.0						
	40.5	636	2.1	71.27	18.0						
	51.4	501	2.4	56.21	18.0						
	14.4	1868	1.0	97.80	18.0	A503 - 100L/4B F503 - 100L/4B	73	93			
	16.5	1630	1.1	85.33	18.0						
	17.9	1502	1.2	78.64	18.0						
	19.8	1361	1.3	71.27	18.0						
	25.1	1074	1.5	56.21	18.0						
	17.0	1585	1.0	56.21	18.0	A503 - 132S/6B F503 - 132S/6B	93	93			
	169.9	164	4.0	8.30	5.0	A601 - 100L/4B F601 - 100L/4B	58	95			
	115.1	242	2.7	8.30	5.0	A/F 601 - 112M/6 A/F 601 - 132S/6B	78	95			
128.1	217	3.0	7.45	5.0							
155.2	179	3.6	6.15	5.0							
183.7	151	4.1	5.20	5.0							
27.7	993	3.3	50.91	22.0	A602 - 100L/4B F602 - 100L/4B	101	97				
31.1	883	3.7	45.27	22.0							
37.1	741	3.8	38.00	22.0							
18.8	1466	2.3	50.91	22.0	A/F 602 - 112M/6 A/F 602 - 132S/6B	121	97				
21.1	1304	2.5	45.27	22.0							
23.4	1175	2.8	40.81	22.0							
25.1	1094	2.6	38.00	22.0							
28.3	973	3.3	33.79	22.0							
31.5	874	3.7	30.35	22.0							
33.7	817	4.0	28.36	22.0							

P_1 [кВт]	n_2 [мин ⁻¹]	M_2 [Нм]	f_B	i	F_R [кН]	Редуктор		
3.00	11.9	2165	1.2	242.67	22.0	A603 - 100L/2A F603 - 100L/2A	98	97
	13.4	1923	1.4	215.56	22.0			
	14.9	1734	1.5	194.31	22.0			
	16.0	1616	1.6	181.13	22.0			
	18.0	1436	1.8	160.90	22.0			
	20.1	1281	2.0	143.57	22.0			
	21.5	1198	2.2	134.25	22.0			
	23.9	1080	2.4	121.02	22.0			
	28.8	894	2.9	100.21	22.0			
	30.9	835	3.1	93.60	22.0			
34.3	753	3.5	84.37	22.0				
36.1	714	3.7	79.98	22.0				
	7.3	3711	0.9	194.31	22.0	A603 - 100L/4B F603 - 100L/4B	101	97
	7.8	3460	1.0	181.13	22.0			
	8.8	3073	1.1	160.90	22.0			
	9.8	2742	1.3	143.57	22.0			
	10.5	2564	1.4	134.25	22.0			
	11.7	2311	1.5	121.02	22.0			
	14.1	1914	1.8	100.21	22.0			
	15.1	1788	2.0	93.60	22.0			
	16.7	1611	2.2	84.37	22.0			
	17.6	1528	2.3	79.98	22.0			
	20.2	1334	2.6	69.87	22.0			
	7.1	3786	0.9	134.25	22.0	A603 - 132S/6B F603 - 132S/6B	121	97
	7.9	3413	1.0	121.02	22.0			
	9.5	2826	1.2	100.21	22.0	A/F 603 - 112M/6 A/F 603 - 132S/6B	121	97
	10.2	2640	1.3	93.60	22.0			
	11.3	2379	1.5	84.37	22.0			
	11.9	2255	1.6	79.98	22.0			
	13.7	1970	1.8	69.87	22.0			
	17.1	1572	2.2	55.75	22.0	A603 - 132S/6B F603 - 132S/6B	121	97
	21.4	1287	3.9	44.67	30.0	A702 - 132S/6B F702 - 132S/6B	151	101
	11.1	2321	1.6	260.15	30.0	A703 - 100L/2A F703 - 100L/2A	128	101
	12.5	2064	1.8	231.34	30.0			
	13.9	1854	2.0	207.78	30.0			
	15.2	1691	2.2	189.54	30.0			
	16.7	1545	2.4	173.11	30.0			
	18.6	1387	2.7	155.48	30.0			
	19.9	1293	2.9	144.94	30.0			
	22.5	1145	3.3	128.35	30.0			
	24.3	1060	3.5	118.75	30.0			
	26.6	968	3.9	108.46	30.0			
	5.4	4969	1.0	260.15	30.0	A703 - 100L/4B F703 - 100L/4B	131	101
	6.1	4419	1.1	231.34	30.0			
	6.8	3969	1.3	207.78	30.0			
	7.4	3620	1.4	189.54	30.0			
	8.1	3306	1.5	173.11	30.0			
	9.1	2970	1.7	155.48	30.0			
	9.7	2768	1.8	144.94	30.0			
	11.0	2451	2.0	128.35	30.0			
	11.9	2268	2.2	118.75	30.0			
	13.0	2072	2.4	108.46	30.0			
	14.0	1917	2.6	100.38	30.0			
	15.7	1718	2.9	89.95	30.0			
	16.9	1592	3.1	83.35	30.0			
	19.1	1408	3.6	73.70	30.0			
	20.9	1286	3.9	67.31	30.0			
	5.0	5345	0.9	189.54	30.0	A703 - 112M/6 F703 - 112M/6	137	101
	5.5	4882	1.0	173.11	30.0			



P_1 [кВт]	n_2 [мин ⁻¹]	M_2 [Нм]	f_B	i	F_R [кН]	Редуктор					
3.00	6.1	4385	1.1	155.48	30.0	A/F 703 - 112M/6 A/F 703 - 132S/6B	151	101			
	6.6	4087	1.2	144.94	30.0						
	7.4	3620	1.4	128.35	30.0						
	8.0	3349	1.5	118.75	30.0						
	8.8	3058	1.6	108.46	30.0						
	9.5	2831	1.8	100.38	30.0						
	10.6	2537	2.0	89.95	30.0						
	11.5	2350	2.1	83.35	30.0						
	13.0	2078	2.4	73.70	30.0						
	14.2	1898	2.6	67.31	30.0						
	17.1	1572	3.2	55.75	30.0				A703 - 132S/6B F703 - 132S/6B	151	101
	20.9	1288	3.9	45.67	30.0						
	4.00	454.1	77	1.0	6.36				2.7	A252 - 100L/2C F252 - 100L/2C	36
		602.3	58	1.2	4.80	2.6					
		209.3	168	1.1	13.81	4.2	A302 - 100L/2C F302 - 100L/2C	38	81		
		240.8	146	1.3	12.00	4.1					
		275.2	128	1.4	10.50	4.1					
		317.2	111	1.4	9.11	4.0					
		393.7	89	1.3	7.34	3.8					
517.9		68	1.8	5.58	3.6	A/F 302 - 100L/2C A/F 302 - 112M/2A	45	81			
256.3		143	1.1	5.58	4.1	A302 - 112M/4B F302 - 112M/4B	47	81			
489.1		73	1.0	5.91	2.0	A351 - 100L/2C F351 - 100L/2C	33	83			
541.9		66	1.1	5.33	1.9						
596.3		60	1.2	4.85	1.9						
710.7		51	1.3	4.07	1.8						
770.7		47	1.4	3.75	1.8	A/F 351 - 100L/2C A/F 351 - 112M/2A	40	83			
896.9	40	1.5	3.22	1.7							
1103.1	33	1.6	2.62	1.6							
1331.8	27	1.7	2.17	1.6							
1993.1	18	2.5	1.45	1.4							
2223.1	16	1.9	1.30	1.4							
381.3	97	0.9	3.75	2.0	A351 - 112M/4B F351 - 112M/4B	42	83				
443.8	83	1.0	3.22	2.0							
545.8	68	1.0	2.62	1.9							
659.0	56	1.1	2.17	1.8							
986.2	38	1.6	1.45	1.7							
1100.0	34	1.2	1.30	1.6							
100.0	351	1.0	28.89	6.2	A352 - 100L/2C F352 - 100L/2C	43	85				
108.7	323	1.1	26.59	6.3							
115.0	306	1.2	25.13	6.4							
131.2	268	1.3	22.03	6.4							
142.3	247	1.4	20.31	6.5							
157.9	223	1.6	18.30	6.1	A/F 352 - 100L/2C A/F 352 - 112M/2A	50	85				
171.2	205	1.6	16.88	6.0							
199.0	177	1.8	14.52	5.9							
246.2	143	2.0	11.74	5.6							
296.4	119	2.3	9.75	5.4							
331.0	106	2.4	8.73	5.3							
409.3	86	2.5	7.06	5.0							
493.2	71	2.7	5.86	4.8							

P_1 [кВт]	n_2 [мин ⁻¹]	M_2 [Нм]	f_B	i	F_R [кН]	Редуктор		
4.00	78.1	469	1.0	18.30	6.5	A352 - 112M/4B F352 - 112M/4B	52	85
	84.7	433	1.0	16.88	6.4			
	98.5	372	1.2	14.52	6.4			
	121.8	301	1.3	11.74	6.3			
	146.7	250	1.5	9.75	6.1			
	163.8	224	1.5	8.73	6.0			
	202.5	181	1.6	7.06	5.8			
	244.0	150	1.7	5.86	5.6			
	350.3	103	1.2	8.25	3.5	A401 - 100L/2C F401 - 100L/2C	33	87
	400.2	90	1.4	7.22	3.4			
	504.4	71	1.8	5.73	3.2	A/F 401 - 100L/2C A/F 401 - 112M/2A	39	87
	559.0	64	2.0	5.17	3.1			
	616.2	58	2.1	4.69	3.0			
	735.4	49	2.3	3.93	2.8			
	798.3	45	2.5	3.62	2.8			
	929.3	39	2.5	3.11	2.7			
	1146.8	31	2.9	2.52	2.5			
	1389.4	26	3.5	2.08	2.4			
	2206.1	16	3.7	1.31	2.0			
	249.6	148	1.1	5.73	3.7	A401 - 112M/4B F401 - 112M/4B	42	87
	276.6	134	1.3	5.17	3.6			
	304.9	122	1.3	4.69	3.6			
	363.9	102	1.5	3.93	3.4			
	395.0	94	1.6	3.62	3.3			
	459.8	81	1.6	3.11	3.2			
	567.5	65	1.8	2.52	3.0			
	687.5	54	2.2	2.08	2.9			
	1091.6	34	2.4	1.31	2.5			
	63.7	552	1.2	45.38	12.0	A402 - 100L/2C F402 - 100L/2C	54	89
	72.8	483	1.3	39.72	12.0			
	79.3	443	1.4	36.44	12.0			
	91.7	383	1.7	31.50	12.0	A/F 402 - 100L/2C A/F 402 - 112M/2A	60	89
	100.0	351	1.7	28.89	12.0			
	114.2	308	2.1	25.30	12.0			
	126.1	279	2.3	22.91	12.0			
	144.9	242	2.6	19.94	11.7			
	166.4	211	2.9	17.37	11.3			
	180.5	195	3.1	16.01	11.1			
	199.3	176	3.0	14.50	10.8			
	232.3	151	3.5	12.44	10.4			
	252.2	139	3.5	11.46	10.2			
	314.1	112	4.0	9.20	9.6			
	45.4	808	1.1	31.50	12.0	A402 - 112M/4B F402 - 112M/4B	63	89
	49.5	741	1.1	28.89	12.0			
	56.5	649	1.3	25.30	12.0			
	62.4	588	1.4	22.91	12.0			
	71.7	511	1.7	19.94	12.0			
	82.3	445	1.9	17.37	12.0			
89.3	411	1.9	16.01	12.0				
98.6	372	1.9	14.50	12.0				
115.0	319	2.2	12.44	12.0				
124.8	294	2.2	11.46	12.0				
155.4	236	2.5	9.20	11.5				
171.6	214	2.8	8.33	11.2				
198.1	185	3.0	7.22	10.8				
246.7	149	3.7	5.80	10.2				
272.4	135	3.7	5.25	9.9				
41.9	875	1.0	22.91	12.0	A402 - 132M/6A F402 - 132M/6A	63	89	
48.2	762	1.1	19.94	12.0				
55.3	664	1.3	17.37	12.0				
60.0	612	1.3	16.01	12.0				
66.2	554	1.3	14.50	12.0				
77.1	475	1.5	12.44	12.0				
83.8	438	1.5	11.46	12.0				
104.3	351	1.7	9.20	12.0				
115.2	318	1.9	8.33	12.0				
133.0	276	2.0	7.22	12.0				
165.6	221	2.5	5.80	11.4				
182.9	201	2.5	5.25	11.1				



P_1 [кВт]	n_2 [мин ⁻¹]	M_2 [Нм]	f_B	i	F_R [кН]	Редуктор			
4.00	58.2	591	1.1	49.64	3.1	A403 - 100L/2C F403 - 100L/2C	54	89	
	337.6 380.3 468.6 514.7	106 94 77 70	2.5 2.8 3.3 3.5	8.56 7.60 6.17 5.62	4.0 3.9 3.7 3.6	A/F 501 - 100L/2C A/F 501 - 112M/2A	51	91	
	167.1 188.2 231.9 254.7 302.1 352.3 378.5 433.3	222 197 160 146 123 105 98 86	1.6 1.8 2.1 2.3 2.6 3.0 3.2 3.6	8.56 7.60 6.17 5.62 4.73 4.06 3.78 3.30	4.0 4.0 4.0 4.0 4.0 4.0 3.9 3.8	A501 - 112M/4B F501 - 112M/4B	53	91	
	112.2 126.3 155.7 171.0 202.8 236.5 254.1 290.9 371.6 488.4 658.8 724.9	330 293 238 217 183 157 146 127 100 76 56 51	1.1 1.2 1.4 1.5 1.8 2.0 2.1 2.4 2.8 3.0 3.9 3.9	8.56 7.60 6.17 5.62 4.73 4.06 3.78 3.30 2.58 1.97 1.46 1.32	4.0 4.0 4.0 4.0 4.0 4.0 4.0 4.0 3.9 3.7 4.0 4.0	A501 - 132M/6A F501 - 132M/6A	73	91	
	59.3 66.7 73.7 83.0 91.5 102.3 107.1	593 527 477 424 384 344 328	2.0 2.3 2.5 2.8 3.1 3.5 3.7	48.77 43.32 39.21 34.83 31.57 28.26 26.98	18.0 18.0 17.7 17.1 16.7 16.2 16.0	A/F 502 - 100L/2C A/F 502 - 112M/2A	78	93	
	29.3 33.0 36.5 41.1 45.3 50.6 53.0 61.8 65.9 72.7 76.0 84.8 94.5 104.3	1251 1111 1006 893 810 725 692 593 556 504 482 432 388 352	1.3 1.4 1.6 1.8 2.0 2.2 2.3 2.7 2.9 3.2 3.1 3.5 3.9 4.0	48.77 43.32 39.21 34.83 31.57 28.26 26.98 23.14 21.69 19.66 18.81 16.86 15.13 13.71	18.0 18.0 18.0 18.0 18.0 18.0 18.0 18.0 18.0 17.6 17.4 16.9 16.5 16.0	A502 - 112M/4B F502 - 112M/4B	80	93	
	22.2 24.5 27.6 30.4 34.0 35.6 41.5 44.3 48.8 51.0 56.9 63.5 70.0 85.7 106.6 117.6 127.2 158.2 174.5	1655 1498 1331 1206 1080 1031 884 829 751 719 644 578 524 428 344 312 288 232 210	1.0 1.1 1.2 1.3 1.5 1.6 1.8 1.9 2.1 2.1 2.3 2.6 2.7 2.6 2.6 2.6 2.8 3.0 3.3	43.32 39.21 34.83 31.57 28.26 26.98 23.14 21.69 19.66 18.81 16.86 15.13 13.71 11.20 9.01 8.16 7.55 6.07 5.50	18.0 18.0 18.0 18.0 18.0 18.0 18.0 18.0 18.0 18.0 18.0 18.0 17.9 17.0 16.1 15.7 15.4 14.5 14.1	A502 - 132M/6A F502 - 132M/6A	100	93	

P_1 [кВт]	n_2 [мин ⁻¹]	M_2 [Нм]	f_B	i	F_R [кН]	Редуктор		
4.00	29.5 33.9 36.7	1163 1015 936	1.2 1.3 1.4	97.80 85.33 78.64	18.0 18.0 18.0	A503 - 100L/2C F503 - 100L/2C	71	93
	40.6 51.4	848 669	1.6 1.8	71.27 56.21	18.0 18.0	A/F 503 - 100L/2C A/F 503 - 112M/2A	78	93
	20.1 25.4	1790 1411	1.0 1.1	71.27 56.21	18.0 18.0	A503 - 112M/4B F503 - 112M/4B	80	93
	172.3 191.8 232.4	215 193 159	3.0 3.4 4.0	8.30 7.45 6.15	5.0 5.0 5.0	A601 - 112M/4B F601 - 112M/4B	65	96
	115.7 128.8 156.0 184.6 199.5 224.4	320 288 238 201 186 165	2.0 2.3 2.7 3.1 3.3 3.7	8.30 7.45 6.15 5.20 4.81 4.28	5.0 5.0 5.0 5.0 5.0 5.0	A601 - 132M/6A F601 - 132M/6A	85	96
	56.8	619	4.0	50.91	22.0	A/F 602 - 100L/2C A/F 602 - 112M/2A	106	97
	28.1 31.6 35.0 37.6 42.3 47.1	1306 1161 1047 975 867 778	2.5 2.8 3.2 2.9 3.7 4.1	50.91 45.27 40.81 38.00 33.79 30.35	22.0 22.0 22.0 22.0 22.0 22.0	A602 - 112M/4B F602 - 112M/4B	108	97
	18.9 21.2 23.5 25.3 28.4 31.6 33.8 37.5 40.6 45.3	1965 1747 1575 1467 1304 1171 1095 987 913 817	1.7 1.9 2.1 1.9 2.5 2.7 3.0 3.3 3.6 3.9	50.91 45.27 40.81 38.00 33.79 30.35 28.36 25.57 23.66 21.17	22.0 22.0 22.0 22.0 22.0 22.0 22.0 22.0 22.0 22.0	A602 - 132M/6A F602 - 132M/6A	128	97
	14.9 16.0 18.0	2312 2155 1914	1.1 1.2 1.4	194.31 181.13 160.90	22.0 22.0 22.0	A603 - 100L/2C F603 - 100L/2C	99	97
	20.1 21.5 23.9 28.8 30.9 34.3 36.1 41.4	1708 1597 1440 1192 1113 1004 951 831	1.5 1.6 1.8 2.2 2.4 2.6 2.8 3.2	143.57 134.25 121.02 100.21 93.60 84.37 79.98 69.87	22.0 22.0 22.0 22.0 22.0 22.0 22.0 22.0	A/F 603 - 100L/2C A/F 603 - 112M/2A	106	97
	10.0 10.7 11.8 14.3 15.3 16.9 17.9 20.5	3605 3371 3039 2516 2350 2119 2008 1754	1.0 1.0 1.2 1.4 1.5 1.7 1.7 2.0	143.57 134.25 121.02 100.21 93.60 84.37 79.98 69.87	22.0 22.0 22.0 22.0 22.0 22.0 22.0 22.0	A603 - 112M/4B F603 - 112M/4B	108	97
	9.6 10.3 11.4 12.0 13.7 17.2	3748 3501 3156 2992 2613 2085	0.9 1.0 1.1 1.2 1.3 1.7	100.21 93.60 84.37 79.98 69.87 55.75	22.0 22.0 22.0 22.0 22.0 22.0	A603 - 132M/6A F603 - 132M/6A	128	97
	123.1 151.6	301 244	3.3 3.7	7.80 6.33	6.0 6.0	A701 - 132M/6A F701 - 132M/6A	88	99
	21.5 26.2 28.7	1706 1398 1277	2.9 3.6 3.9	44.67 36.60 33.43	30.0 30.0 30.0	A702 - 132M/6A F702 - 132M/6A	158	99



P_1 [кВт]	n_2 [мин ⁻¹]	M_2 [Нм]	f_B	i	F_R [кН]	Редуктор		
4.00	11.1	3095	1.2	260.15	30.0	A703 - 100L/2C F703 - 100L/2C	129	101
	12.5	2752	1.4	231.34	30.0			
	13.9	2472	1.5	207.78	30.0	A/F 703 - 100L/2C A/F 703 - 112M/2A	135	101
	15.2	2255	1.7	189.54	30.0			
	16.7	2059	1.8	173.11	30.0			
	18.6	1850	2.0	155.48	30.0			
	19.9	1724	2.2	144.94	30.0			
	22.5	1527	2.5	128.35	30.0			
	24.3	1413	2.7	118.75	30.0			
	26.6	1290	2.9	108.46	30.0			
	28.8	1194	3.1	100.38	30.0			
	32.1	1070	3.5	89.95	30.0			
	34.7	992	3.8	83.35	30.0			
	6.9	5217	1.0	207.78	30.0	A703 - 112M/4B F703 - 112M/4B	137	101
	7.5	4759	1.1	189.54	30.0			
	8.3	4347	1.2	173.11	30.0			
	9.2	3904	1.3	155.48	30.0			
	9.9	3640	1.4	144.94	30.0			
	11.1	3223	1.6	128.35	30.0			
	12.0	2982	1.7	118.75	30.0			
	13.2	2723	1.8	108.46	30.0			
	14.2	2521	2.0	100.38	30.0			
	15.9	2259	2.2	89.95	30.0			
	17.2	2093	2.4	83.35	30.0			
	19.4	1851	2.7	73.70	30.0			
	21.2	1690	3.0	67.31	30.0			
	7.5	4888	1.0	128.35	30.0	A703 - 132M/6A F703 - 132M/6A	158	101
	8.1	4522	1.1	118.75	30.0			
	8.9	4130	1.2	108.46	30.0			
	9.6	3822	1.3	100.38	30.0			
	10.7	3425	1.5	89.95	30.0			
	11.5	3174	1.6	83.35	30.0			
	13.0	2806	1.8	73.70	30.0			
	14.3	2563	2.0	67.31	30.0			
	17.2	2123	2.4	55.75	30.0			
	21.0	1739	2.9	45.67	30.0			
	4.7	7834	1.0	205.73	55.0	A903 - 132M/6A F903 - 132M/6A	235	103
	5.2	7069	1.1	185.64	55.0			
	6.2	5867	1.4	154.07	55.0			
	6.9	5309	1.5	139.41	55.0			
	7.5	4888	1.6	128.36	55.0			
	8.3	4411	1.8	115.83	55.0			
	9.2	3976	2.0	104.41	55.0			
	10.0	3661	2.2	96.13	55.0			
	11.1	3291	2.4	86.43	55.0			
	12.1	3013	2.7	79.13	55.0			
	13.4	2719	2.9	71.40	55.0			
15.2	2400	3.3	63.02	55.0				
16.2	2257	3.5	59.26	55.0				
17.9	2043	3.9	53.66	55.0				
4.80	259.0	170	0.9	5.58	3.8	A302 - 112M/4 F302 - 112M/4	47	81
	995.4	44	1.4	1.45	1.6	A351 - 112M/4 F351 - 112M/4	42	83
	1109.0	40	1.0	1.30	1.6			
	99.5	442	1.0	14.52	5.9	A352 - 112M/4 F352 - 112M/4	52	85
	123.1	358	1.1	11.74	5.9			
	148.2	297	1.2	9.75	5.8			
	165.5	266	1.3	8.73	5.7			
	204.7	215	1.3	7.06	5.5			
	246.6	178	1.5	5.86	5.4			

P_1 [кВт]	n_2 [мин ⁻¹]	M_2 [Нм]	f_B	i	F_R [кН]	Редуктор		
4.80	252.2	176	1.0	5.73	3.6	A401 - 112M/4 F401 - 112M/4	42	87
	279.5	159	1.1	5.17	3.5			
	308.1	144	1.1	4.69	3.5			
	367.7	121	1.2	3.93	3.3			
	399.2	111	1.3	3.62	3.3			
	464.6	96	1.4	3.11	3.2			
	573.4	78	1.5	2.52	3.0			
	694.7	64	1.9	2.08	2.8			
	1103.1	40	2.0	1.31	2.5			
	57.1	770	1.1	25.30	12.0			
63.1	698	1.2	22.91	12.0				
72.5	607	1.4	19.94	12.0				
83.2	529	1.6	17.37	12.0				
90.3	488	1.6	16.01	12.0				
99.7	442	1.6	14.50	12.0				
116.2	379	1.8	12.44	11.9				
126.1	349	1.9	11.46	11.7				
157.1	280	2.1	9.20	11.2				
173.5	254	2.4	8.33	10.9				
200.1	220	2.5	7.22	10.6				
149.1	177	3.1	5.80	10.0	A501 - 112M/4 F501 - 112M/4	53	91	
275.2	160	3.1	5.25	9.8				
168.8	263	1.3	8.56	4.0				
190.1	234	1.5	7.60	4.0				
234.2	190	1.8	6.17	4.0				
257.1	173	1.9	5.62	4.0				
305.3	146	2.2	4.73	4.0				
356.0	125	2.6	4.06	4.0				
382.5	116	2.7	3.78	3.9				
437.9	102	3.1	3.30	3.7				
559.4	79	3.5	2.58	3.5				
29.6	1485	1.1	48.77	18.0	A502 - 112M/4 F502 - 112M/4	80	93	
33.4	1292	1.2	43.32	18.0				
36.9	1169	1.4	39.21	18.0				
41.5	1039	1.5	34.83	18.0				
45.8	941	1.7	31.57	18.0				
51.1	843	1.9	28.26	18.0				
53.6	805	2.0	26.98	18.0				
62.5	690	2.3	23.14	17.7				
66.6	647	2.5	21.69	17.5				
73.5	586	2.7	19.66	17.1				
76.8	561	2.7	18.81	16.9				
85.7	503	3.0	16.86	16.5				
95.5	451	3.3	15.13	16.1				
105.4	409	3.4	13.71	15.7				
25.7	1676	1.0	56.21	18.0	A503 - 112M/4 F503 - 112M/4	80	93	
174.1	255	2.5	8.30	5.0	A601 - 112M/4 F601 - 112M/4	108	95	
193.8	229	2.8	7.45	5.0				
234.8	189	3.4	6.15	5.0				
277.9	160	3.9	5.20	5.0				
28.4	1550	2.1	50.91	22.0	A602 - 112M/4 F602 - 112M/4	108	97	
31.9	1379	2.4	45.27	22.0				
35.4	1243	2.7	40.81	22.0				
38.0	1157	2.4	38.00	22.0				
42.8	1029	3.1	33.79	22.0				
47.6	924	3.5	30.35	22.0				
50.9	864	3.8	28.36	22.0				
11.9	3609	1.0	121.02	22.0	A603 - 112M/4 F603 - 112M/4	108	97	
14.4	2988	1.2	100.21	22.0				
15.4	2791	1.3	93.60	22.0				
17.1	2516	1.4	84.37	22.0				
18.1	2385	1.5	79.98	22.0				
20.7	2084	1.7	69.87	22.0				



P_1 [кВт]	n_2 [мин ⁻¹]	M_2 [Нм]	f_B	i	F_R [кН]	Редуктор		
4.80	8.3	5162	1.0	173.11	30.0	A703 - 112M/4 F703 - 112M/4	137	101
	9.3	4636	1.1	155.48	30.0			
	10.0	4322	1.2	144.94	30.0			
	11.3	3827	1.3	128.35	30.0			
	12.2	3541	1.4	118.75	30.0			
	13.3	3234	1.5	108.46	30.0			
	14.4	2993	1.7	100.38	30.0			
	16.1	2682	1.9	89.95	30.0			
	17.3	2485	2.0	83.35	30.0			
	19.6	2198	2.3	73.70	30.0			
21.5	2007	2.5	67.31	30.0				
5.50	519.6	93	1.3	5.58	3.4	A302 - 112M/2C F302 - 112M/2C	45	81
	773.3	64	1.1	3.75	1.7	A351 - 112M/2C F351 - 112M/2C	43	83
	900.0	55	1.1	3.22	1.6			
	1107.3	45	1.2	2.62	1.6			
	1338.5	37	1.2	2.17	1.5			
	1997.8	25	1.8	1.45	1.4			
	2225.6	22	1.4	1.30	1.3			
	158.5	305	1.1	18.30	5.6	A352 - 112M/2C F352 - 112M/2C	50	85
	171.9	281	1.2	16.88	5.5			
	199.8	242	1.3	14.52	5.4			
	247.1	196	1.5	11.74	5.3			
	297.4	162	1.7	9.75	5.1			
	332.2	145	1.8	8.73	5.0			
	410.9	118	1.8	7.06	4.8			
	494.6	98	2.0	5.86	4.6			
	506.3	98	1.3	5.73	3.0	A401 - 112M/2C F401 - 112M/2C	40	87
	561.3	88	1.4	5.17	3.0			
	618.0	80	1.5	4.69	2.9			
	737.3	67	1.7	3.93	2.8			
	800.0	62	1.8	3.63	2.7			
	932.1	53	1.8	3.11	2.6			
	1149.1	43	2.1	2.52	2.4			
	1392.0	35	2.5	2.08	2.3			
	2209.5	22	2.7	1.31	2.0			
	92.1	525	1.2	31.50	12.0	A402 - 112M/2C F402 - 112M/2C	61	89
	100.4	481	1.2	28.89	12.0			
	114.6	422	1.5	25.30	11.7	A/F 402 - 112M/2C A/F 402 - 132S/2A	74	89
126.6	382	1.7	22.91	11.5				
145.4	332	1.9	19.94	11.2				
167.0	289	2.2	17.37	10.9				
181.1	267	2.2	16.01	10.7				
200.0	242	2.2	14.50	10.4				
233.1	207	2.5	12.44	10.0				
253.1	191	2.6	11.46	9.9				
315.2	153	2.9	9.20	9.3				
348.1	139	3.2	8.33	9.1				
401.7	120	3.4	7.22	8.7				
552.4	87	4.3	5.25	8.2				
60.0	841	1.0	16.01	12.0	A402 - 132M/6B F402 - 132M/6B			
77.2	653	1.1	12.44	12.0				
83.8	602	1.1	11.46	12.0				
104.3	483	1.2	9.20	11.8				
115.2	438	1.4	8.33	11.6				
133.0	379	1.5	7.22	11.3				
165.5	305	1.8	5.80	10.9				
182.9	276	1.8	5.25	10.6				

P_1 [кВт]	n_2 [мин ⁻¹]	M_2 [Нм]	f_B	i	F_R [кН]	Редуктор		
5.50	57.1	883	1.0	25.30	12.0	A402 - 132S/4C F402 - 132S/4C	79	89
	63.1	799	1.1	22.91	12.0			
	72.5	696	1.2	19.94	12.0			
	83.2	606	1.4	17.37	12.0			
	90.3	559	1.4	16.01	12.0			
	99.7	506	1.4	14.50	11.9			
	116.2	434	1.6	12.44	11.6			
	126.1	400	1.6	11.46	11.4			
	157.1	321	1.9	9.20	10.9			
	173.5	291	2.1	8.33	10.7			
200.1	252	2.2	7.22	10.4				
249.1	202	2.7	5.80	9.8				
275.2	183	2.7	5.25	9.6				
	338.8	146	1.8	8.56	4.0	A/F 501 - 112M/2C A/F 501 - 132S/2A	64	91
	381.6	129	2.0	7.60	3.8			
	470.0	105	2.4	6.17	3.7			
	516.0	96	2.6	5.62	3.6			
	613.1	81	3.0	4.73	3.3			
	714.3	69	3.5	4.06	3.2			
	767.2	64	3.6	3.78	3.1			
	155.7	327	1.0	6.17	4.0	A501 - 132M/6B F501 - 132M/6B	78	91
	171.0	298	1.1	5.62	4.0			
	202.8	251	1.3	4.73	4.0			
	236.5	215	1.5	4.06	4.0			
	254.1	200	1.5	3.78	4.0			
	290.9	175	1.8	3.30	4.0			
	371.6	137	2.0	2.58	3.9			
	488.4	104	2.2	1.97	3.6			
	658.8	77	2.8	1.46	3.3			
	724.9	70	2.8	1.32	3.2			
	168.8	302	1.2	8.56	4.0	A501 - 132S/4C F501 - 132S/4C	69	91
	190.1	268	1.3	7.60	4.0			
	234.2	218	1.6	6.17	4.0			
	257.1	198	1.7	5.62	4.0			
	305.5	167	1.9	4.73	4.0			
	355.9	143	2.2	4.06	3.9			
	382.3	133	2.3	3.78	3.8			
	437.9	116	2.7	3.30	3.7			
	560.1	91	3.1	2.58	3.4			
	733.5	69	3.3	1.97	3.2			
	59.5	813	1.5	48.77	17.5	A/F 502 - 112M/2C A/F 502 - 132S/2A	91	93
	66.9	722	1.7	43.32	17.2			
	74.0	653	1.8	39.21	16.8			
	83.3	580	2.1	34.83	16.4			
	91.9	526	2.3	31.57	16.0			
	102.6	471	2.5	28.26	15.6			
	107.5	450	2.7	26.98	15.5			
	125.3	386	3.1	23.14	14.9			
	133.7	361	3.3	21.69	14.7			
	147.5	328	3.7	19.66	14.3			
	154.2	313	3.6	18.81	14.1			
	172.0	281	4.0	16.86	13.7			
		30.4	1658	1.0	31.57			
34.0		1484	1.1	28.26	18.0			
35.6		1417	1.1	26.98	18.0			
41.5		1215	1.3	23.14	18.0			
44.3		1139	1.4	21.69	18.0			
48.8		1033	1.5	19.66	18.0			
51.0		988	1.5	18.81	17.9			
56.9		886	1.7	16.86	17.6			
63.5		794	1.9	15.13	17.3			
70.0		720	1.9	13.71	16.9			
85.7		588	1.9	11.20	16.3			
106.6		473	1.9	9.01	15.5			
117.6		429	1.9	8.16	15.1			
127.2		396	2.0	7.55	14.8			
158.2		319	2.2	6.07	14.1			
174.5		289	2.4	5.50	13.7			



P_1 [кВт]	n_2 [мин ⁻¹]	M_2 [Нм]	f_B	i	F_R [кН]	Редуктор		
5.50	29.6	1702	0.9	48.77	18.0	A502 - 132S/4C F502 - 132S/4C	96	93
	33.4	1512	1.1	43.32	18.0			
	36.9	1368	1.2	39.21	18.0			
	41.5	1215	1.3	34.83	18.0			
	45.8	1102	1.5	31.57	18.0			
	51.1	986	1.6	28.26	17.8			
	53.6	941	1.7	26.98	17.7			
	62.4	807	2.0	23.14	17.2			
	66.6	757	2.1	21.69	17.0			
	73.5	686	2.3	19.66	16.7			
	76.8	656	2.3	18.81	16.6			
	85.7	588	2.5	16.86	16.2			
	95.5	528	2.8	15.13	15.8			
	105.4	478	2.9	13.71	15.4			
	129.0	391	2.8	11.20	14.7			
	160.4	314	2.9	9.01	13.9			
	177.0	285	2.8	8.16	13.6			
	191.4	263	3.0	7.55	13.3			
	238.1	212	3.3	6.07	12.5			
	262.7	192	3.6	5.50	12.2			
	40.7	1162	1.2	71.27	18.0	A503 - 112M/2C F503 - 112M/2C	78	93
	51.6	916	1.3	56.21	18.0			
	349.4	141	3.4	8.30	5.0	A/F 601 - 112M/2C A/F 601 - 132S/2A	76	95
	389.0	127	3.8	7.45	4.9			
	115.7	440	1.5	8.30	5.0	A601 - 132M/6B F601 - 132M/6B	90	95
	128.8	396	1.6	7.45	5.0			
	156.0	327	2.0	6.15	5.0			
	184.6	276	2.2	5.20	5.0			
	199.5	255	2.4	4.81	5.0			
	224.4	227	2.7	4.28	5.0			
	263.0	194	3.1	3.65	5.0			
	297.5	171	3.5	3.23	5.0			
	174.1	293	2.2	8.30	5.0	A601 - 132S/4C F601 - 132S/4C	92	95
	193.8	263	2.5	7.45	5.0			
	234.8	217	2.9	6.15	5.0			
	277.9	183	3.4	5.20	5.0			
	300.3	170	3.7	4.81	5.0			
337.8	151	4.0	4.28	5.0				
57.0	848	2.9	50.91	22.0	A/F 602 - 112M/2C A/F 602 - 132S/2A	119	97	
64.1	754	3.3	45.27	22.0				
71.1	680	3.6	40.81	22.0				
76.3	633	3.3	38.00	22.0				
18.9	2674	1.2	50.91	22.0	A602 - 132M/6B F602 - 132M/6B	133	97	
21.2	2378	1.4	45.27	22.0				
23.5	2143	1.5	40.81	22.0				
25.3	1996	1.4	38.00	22.0				
28.4	1775	1.8	33.79	22.0				
31.6	1594	2.0	30.35	22.0				
33.8	1490	2.2	28.36	22.0				
37.5	1343	2.5	25.57	22.0				
40.6	1243	2.7	23.66	22.0				
45.3	1112	2.9	21.17	22.0				
49.0	1029	3.1	19.59	22.0				
54.5	925	3.5	17.60	22.0				
60.5	833	3.8	15.87	22.0				
28.4	1777	1.9	50.91	22.0				A602 - 132S/4C F602 - 132S/4C
31.9	1580	2.1	45.27	22.0				
35.4	1424	2.3	40.81	22.0				
38.0	1326	2.1	38.00	22.0				
42.8	1179	2.7	33.79	22.0				
47.6	1059	3.0	30.35	22.0				
50.9	990	3.3	28.36	22.0				
56.5	892	3.7	25.57	22.0				
61.1	826	4.0	23.66	22.0				
20.2	2340	1.1	143.57	22.0	A603 - 112M/2C F603 - 112M/2C	106	97	
21.6	2188	1.2	134.25	22.0				
24.0	1973	1.3	121.02	22.0				

P_1 [кВт]	n_2 [мин ⁻¹]	M_2 [Нм]	f_B	i	F_R [кН]	Редуктор		
5.50	28.9	1634	1.6	100.21	22.0	A/F 603 - 112M/2C A/F 603 - 132S/2A	119	97
	31.0	1526	1.7	93.60	22.0			
	34.4	1375	1.9	84.37	22.0			
	36.3	1304	2.0	79.98	22.0			
	41.5	1139	2.3	69.87	22.0			
	13.7	3593	1.0	69.87	22.0	A603 - 132M/6B F603 - 132M/6B	133	97
	17.2	2867	1.2	55.75	22.0			
	14.4	3424	1.0	100.21	22.0	A603 - 132S/4C F603 - 132S/4C	135	97
	15.4	3198	1.1	93.60	22.0			
	17.1	2883	1.2	84.37	22.0			
	18.1	2733	1.3	79.98	22.0			
	20.7	2387	1.5	69.87	22.0			
	25.9	1905	1.8	55.75	22.0			
	52.0	909	2.9	55.75	22.0	A603 - 132S/2A F603 - 132S/2A	119	97
	123.1	414	2.4	7.80	6.0	A701 - 132M/6B F701 - 132M/6B	93	99
	151.6	336	2.7	6.33	6.0			
	181.6	281	3.1	5.29	6.0			
	197.3	258	3.4	4.87	6.0			
	229.9	222	3.8	4.18	6.0			
	185.3	275	3.6	7.80	6.0	A701 - 132S/4C F701 - 132S/4C	84	99
	228.2	223	4.0	6.33	6.0			
	21.5	2346	2.1	44.67	30.0	A702 - 132M/6B F702 - 132M/6B	163	101
	26.2	1922	2.6	36.60	30.0			
	28.7	1756	2.8	33.43	30.0			
	31.7	1590	3.1	30.27	30.0			
	34.4	1464	3.4	27.87	30.0			
	38.7	1303	3.8	24.80	30.0			
32.3	1559	3.2	44.67	30.0	A702 - 132S/4C F702 - 132S/4C	154	101	
39.5	1277	3.9	36.60	30.0				
14.0	3387	1.1	207.78	30.0	A703 - 112M/2C F703 - 112M/2C	135	101	
15.3	3090	1.2	189.54	30.0				
16.8	2822	1.3	173.11	30.0				
18.7	2534	1.5	155.48	30.0	A/F 703 - 112M/2C A/F 703 - 132S/2A	149	101	
20.0	2363	1.6	144.94	30.0				
22.6	2092	1.8	128.35	30.0				
24.4	1936	1.9	118.75	30.0				
26.7	1768	2.1	108.46	30.0				
28.9	1636	2.3	100.38	30.0				
32.2	1466	2.6	89.95	30.0				
34.8	1359	2.8	83.35	30.0				
39.3	1201	3.1	73.70	30.0				
43.1	1097	3.4	67.31	30.0				
9.6	5218	1.0	100.38	30.0	A703 - 132M/6B F703 - 132M/6B	163	101	
10.7	4675	1.1	89.95	30.0				
11.5	4332	1.2	83.35	30.0				
13.0	3831	1.3	73.70	30.0				
14.3	3499	1.4	67.31	30.0				
17.2	2898	1.7	55.75	30.0				
21.0	2374	2.1	45.67	30.0				
9.3	5313	0.9	155.48	30.0	A703 - 132S/4C F703 - 132S/4C	154	101	
10.0	4952	1.0	144.94	30.0				
11.3	4386	1.1	128.35	30.0				
12.2	4058	1.2	118.75	30.0				
13.3	3706	1.3	108.46	30.0				
14.4	3430	1.5	100.38	30.0				
16.1	3073	1.6	89.95	30.0				
17.3	2848	1.8	83.35	30.0				
19.6	2518	2.0	73.70	30.0				
21.5	2300	2.2	67.31	30.0				
25.9	1905	2.6	55.75	30.0				
31.6	1561	3.2	45.67	30.0				
52.0	949	3.9	55.75	30.0				A703 - 132S/2A F703 - 132S/2A



P_1 [кВт]	n_2 [мин ⁻¹]	M_2 [Нм]	f_B	i	F_R [кН]	Редуктор					
5.50	6.2	7966	1.0	154.07	55.0	A903 - 132M/6B F903 - 132M/6B	238	103			
	6.9	7208	1.1	139.41	55.0						
	7.5	6637	1.2	128.36	55.0						
	8.3	5989	1.3	115.83	55.0						
	9.2	5398	1.5	104.41	55.0						
	10.0	4970	1.6	96.13	55.0						
	11.1	4469	1.8	86.43	55.0						
	12.1	4091	2.0	79.13	55.0						
	13.4	3692	2.2	71.40	55.0						
	15.2	3258	2.5	63.02	55.0						
	16.2	3064	2.6	59.26	55.0						
	17.9	2775	2.9	53.66	55.0						
	7.0	7029	1.1	205.73	55.0				A903 - 132S/4C F903 - 132S/4C	221	103
	7.8	6343	1.3	185.64	55.0						
	9.4	5264	1.5	154.07	55.0						
	10.4	4763	1.7	139.41	55.0						
	11.3	4386	1.8	128.36	55.0						
	12.5	3958	2.0	115.83	55.0						
	13.8	3568	2.2	104.41	55.0						
	15.0	3285	2.4	96.13	55.0						
	16.7	2953	2.7	86.43	55.0						
	18.3	2704	3.0	79.13	55.0						
	20.2	2440	3.3	71.40	55.0						
	22.9	2153	3.7	63.02	55.0						
	24.4	2025	4.0	59.26	55.0						
	14.1	3354	1.8	205.73	55.0	A903 - 132S/2A F903 - 132S/2A	216	103			
	15.6	3026	2.0	185.64	55.0						
	18.8	2511	2.4	154.07	55.0						
	20.8	2273	2.6	139.41	55.0						
	22.6	2092	2.9	128.36	55.0						
	25.0	1888	3.2	115.83	55.0						
	27.8	1702	3.5	104.41	55.0						
	30.2	1567	3.8	96.13	55.0						
7.50	83.5	824	1.0	17.37	10.8	A402 - 132M/4B F402 - 132M/4B	90	89			
	90.6	759	1.1	16.01	10.8						
	100.0	688	1.0	14.50	10.8						
	116.6	590	1.2	12.44	10.6						
	126.5	543	1.2	11.46	10.5						
	157.6	436	1.4	9.20	10.2						
	174.1	395	1.5	8.33	10.1						
	200.8	342	1.6	7.22	9.8						
	250.0	275	2.0	5.80	9.4						
	276.2	249	2.0	5.25	9.2						
	126.6	521	1.2	22.91	10.6				A402 - 132S/2C F402 - 132S/2C	81	89
	145.5	453	1.4	19.94	10.4						
	166.9	395	1.6	17.37	10.2						
	181.1	364	1.6	16.01	10.1						
	200.0	329	1.6	14.50	9.9						
	233.0	283	1.9	12.44	9.6						
	253.1	260	1.9	11.46	9.4						
	315.2	209	2.2	9.20	9.0						
	348.0	189	2.4	8.33	8.8						
	401.7	164	2.5	7.22	8.5						
	500.3	132	3.1	5.80	8.0						
	552.4	119	3.1	5.25	7.8						
	190.8	364	1.0	7.60	4.0	A501 - 132M/4B F501 - 132M/4B	80	91			
	235.0	296	1.2	6.17	4.0						
	258.0	269	1.2	5.62	4.0						
	306.6	227	1.4	4.73	4.0						
	357.1	195	1.6	4.06	3.8						
	383.6	181	1.7	3.78	3.7						
	439.4	158	2.0	3.30	3.6						
	562.0	124	2.3	2.58	3.4						
736.0	94	2.4	1.97	3.1							
993.2	70	3.1	1.46	2.8							
1098.5	63	3.2	1.32	2.8							

P_1 [кВт]	n_2 [мин ⁻¹]	M_2 [Нм]	f_B	i	F_R [кН]	Редуктор		
7.50	338.8	199	1.3	8.56	3.9	A501 - 132S/2C F501 - 132S/2C	71	91
	381.6	176	1.5	7.60	3.7			
	470.0	143	1.8	6.17	3.5			
	516.0	130	1.9	5.62	3.4			
	613.1	110	2.2	4.73	3.3			
	714.3	94	2.5	4.06	3.1			
	767.2	88	2.6	3.78	3.1			
	878.8	77	3.0	3.30	3.0			
	1124.0	60	3.5	2.58	2.8			
	1472.1	46	3.8	1.97	2.7			
	41.6	1652	1.0	34.83	16.3	A502 - 132M/4B F502 - 132M/4B	107	93
	45.9	1497	1.1	31.57	16.3			
	51.3	1340	1.2	28.26	16.2			
	53.7	1279	1.3	26.98	16.1			
	62.7	1097	1.5	23.14	15.9			
	66.9	1029	1.6	21.69	15.8			
	73.8	932	1.7	19.66	15.5			
	77.1	892	1.7	18.81	15.4			
	86.0	800	1.9	16.86	15.2			
	95.8	717	2.1	15.13	14.9			
	105.8	650	2.2	13.71	14.6			
	129.5	531	2.1	11.20	14.0			
	160.9	427	2.1	9.01	13.4			
	177.7	387	2.1	8.16	13.1			
	192.1	358	2.2	7.55	12.8			
	59.5	1108	1.1	48.77	16.2	A502 - 132S/2C F502 - 132S/2C	98	93
	66.9	984	1.2	43.32	15.9			
	74.0	891	1.3	39.21	15.7			
	83.3	791	1.5	34.83	15.4			
	91.9	717	1.7	31.57	15.1			
	102.6	642	1.9	28.26	14.8			
	107.5	613	2.0	26.98	14.7			
	125.3	526	2.3	23.14	14.2			
	133.7	493	2.4	21.69	14.0			
	147.5	447	2.7	19.66	13.7			
	154.2	427	2.6	18.81	13.6			
	172.0	383	2.9	16.86	13.2			
	191.7	344	3.3	15.13	12.9			
	211.6	311	3.4	13.71	12.6			
	258.8	255	3.2	11.20	11.9			
321.9	205	3.3	9.01	11.3				
355.2	186	3.2	8.16	11.0				
384.2	172	3.5	7.55	10.7				
477.8	138	3.8	6.07	10.1				
	41.5	1657	1.0	23.14	16.2	A502 - 160M/6B F502 - 160M/6B	139	93
	44.3	1554	1.0	21.69	16.2			
	48.8	1408	1.1	19.66	16.2			
	51.0	1347	1.1	18.81	16.1			
	56.9	1208	1.2	16.86	16.0			
	63.5	1083	1.4	15.13	15.9			
	70.0	982	1.4	13.71	15.7			
	85.7	802	1.4	11.20	15.2			
	106.6	645	1.4	9.01	14.7			
	117.6	585	1.4	8.16	14.4			
	127.2	541	1.5	7.55	14.1			
	158.2	435	1.6	6.07	13.5			
	174.5	394	1.8	5.50	13.2			
	174.7	398	1.6	8.30	5.0	A601 - 132M/4B F601 - 132M/4B	92	95
	194.6	357	1.8	7.45	5.0			
	235.8	295	2.2	6.15	5.0			
	278.8	249	2.5	5.20	5.0			
	301.3	231	2.7	4.81	5.0			
	339.0	205	3.0	4.28	5.0			
	397.3	175	3.4	3.65	4.8			
	449.3	155	3.9	3.23	4.7			



P_1 [кВт]	n_2 [мин ⁻¹]	M_2 [Нм]	f_B	i	F_R [кН]	Редуктор		
7.50	349.4	193	2.5	8.30	5.0	A601 - 132S/2C F601 - 132S/2C	83	95
	389.0	173	2.8	7.45	4.9			
	471.3	143	3.4	6.15	4.6			
	557.7	121	3.9	5.20	4.4			
	602.6	112	4.2	4.81	4.5			
	115.7	601	1.1	8.30	5.0	A601 - 160M/6B F601 - 160M/6B	92	95
	128.8	539	1.2	7.45	5.0			
	156.0	445	1.4	6.15	5.0			
	184.6	376	1.6	5.20	5.0			
	199.5	348	1.8	4.81	5.0			
	224.4	310	2.0	4.28	5.0			
	263.0	264	2.3	3.65	5.0			
297.5	234	2.6	3.23	5.0				
392.7	177	3.1	2.44	4.8				
480.0	145	3.1	2.00	4.6				
28.5	2414	1.4	50.91	22.0	A602 - 132M/4B F602 - 132M/4B	135	97	
32.0	2147	1.5	45.27	22.0				
35.5	1935	1.7	40.81	22.0				
38.2	1802	1.6	38.00	22.0				
42.9	1602	2.0	33.79	22.0				
47.8	1439	2.2	30.35	22.0				
51.1	1345	2.5	28.36	22.0				
56.7	1212	2.7	25.57	22.0				
61.3	1122	2.9	23.66	22.0				
68.5	1004	3.2	21.17	22.0				
74.0	929	3.4	19.59	22.0				
82.4	835	3.8	17.60	22.0				
57.0	1157	2.1	50.91	22.0	A602 - 132S/2C F602 - 132S/2C	126	97	
64.1	1029	2.4	45.27	22.0				
71.1	927	2.7	40.81	22.0				
76.3	863	2.4	38.00	22.0				
85.8	768	3.1	33.79	22.0				
95.5	690	3.5	30.35	21.9				
102.2	644	3.8	28.36	21.6				
21.2	3243	1.0	45.27	22.0	A602 - 160M/6B F602 - 160M/6B	169	97	
23.5	2923	1.1	40.81	22.0				
25.3	2722	1.0	38.00	22.0				
28.4	2420	1.3	33.79	22.0				
31.6	2174	1.5	30.35	22.0				
33.8	2032	1.6	28.36	22.0				
37.5	1831	1.8	25.57	22.0				
40.6	1695	1.9	23.66	22.0				
45.3	1516	2.1	21.17	22.0				
49.0	1403	2.3	19.59	22.0				
54.5	1261	2.5	17.60	22.0				
60.5	1137	2.8	15.87	22.0				
73.1	941	3.3	13.14	22.0				
88.0	781	3.8	10.91	22.0				
97.6	704	4.0	9.83	21.8				
18.1	3714	0.9	79.98	22.0	A603 - 132M/4B F603 - 132M/4B	135	97	
20.8	3244	1.1	69.87	22.0				
26.0	2589	1.4	55.75	22.0				
28.9	2228	1.2	100.21	22.0	A603 - 132S/2C F603 - 132S/2C	126	97	
31.0	2081	1.3	93.60	22.0				
34.4	1875	1.4	84.37	22.0				
36.3	1778	1.5	79.98	22.0				
41.5	1553	1.7	69.87	22.0				
52.0	1239	2.1	55.75	22.0				
185.9	374	2.7	7.80	6.0	A701 - 132M/4B F701 - 132M/4B	95	99	
228.9	303	3.0	6.33	6.0				
274.3	253	3.5	5.29	6.0				
297.9	233	3.7	4.87	6.0				

P_1 [кВт]	n_2 [мин ⁻¹]	M_2 [Нм]	f_B	i	F_R [кН]	Редуктор					
7.50	123.1	564	1.8	7.80	6.0	A701 - 160M/6B F701 - 160M/6B	129	99			
	151.6	458	2.0	6.33	6.0						
	181.6	383	2.3	5.29	6.0						
	197.3	352	2.5	4.87	6.0						
	229.9	302	2.8	4.18	6.0						
	264.3	263	3.2	3.63	6.0						
	300.9	231	3.6	3.19	6.0						
	320.0	217	3.7	3.00	6.0						
	32.5	2118	2.4	44.67	30.0				A702 - 132M/4B F702 - 132M/4B	165	101
	39.6	1736	2.9	36.60	30.0						
43.4	1585	3.2	33.43	30.0							
47.9	1436	3.5	30.27	30.0							
52.0	1322	3.8	27.87	30.0							
64.9	1015	3.7	44.67	30.0	A702 - 132S/2C F702 - 132S/2C	156	101				
21.5	3200	1.6	44.67	30.0	A702 - 160M/6B F702 - 160M/6B	199	101				
26.2	2621	1.9	36.60	30.0							
28.7	2394	2.1	33.43	30.0							
31.7	2168	2.3	30.27	30.0							
34.4	1996	2.5	27.87	30.0							
38.7	1776	2.8	24.80	30.0							
42.0	1636	3.1	22.84	30.0							
46.0	1494	3.3	20.86	30.0							
49.0	1404	3.6	19.60	30.0							
55.9	1231	3.9	17.18	30.0							
13.4	5036	1.0	108.46	30.0	A703 - 132M/4B F703 - 132M/4B	165	101				
14.4	4661	1.1	100.38	30.0							
16.1	4177	1.2	89.95	30.0							
17.4	3870	1.3	83.35	30.0							
19.7	3422	1.5	73.70	30.0							
21.5	3125	1.6	67.31	30.0							
26.0	2588	1.9	55.75	30.0							
31.7	2121	2.4	45.67	30.0							
18.7	3456	1.1	155.48	30.0	A703 - 132S/2C F703 - 132S/2C	156	101				
20.0	3222	1.2	144.94	30.0							
22.6	2853	1.3	128.35	30.0							
24.4	2640	1.4	118.75	30.0							
26.7	2411	1.6	108.46	30.0							
28.9	2231	1.7	100.38	30.0							
32.2	2000	1.9	89.95	30.0							
34.8	1853	2.0	83.35	30.0							
39.3	1638	2.3	73.70	30.0							
43.1	1496	2.5	67.31	30.0							
52.0	1239	3.0	55.75	30.0							
63.5	1015	3.7	45.67	30.0							
13.0	5169	1.0	73.70	30.0				A703 - 160M/6B F703 - 160M/6B	199	101	
14.3	4721	1.1	67.31	30.0							
17.2	3910	1.3	55.75	30.0							
21.0	3203	1.6	45.67	30.0							
22.6	3042	2.6	42.47	55.0	A902 - 160M/6B F902 - 160M/6B	266	103				
25.0	2745	2.9	38.33	55.0							
30.2	2278	3.5	31.81	55.0							
9.4	7154	1.1	154.07	55.0	A903 - 132M/4B F903 - 132M/4B	227	103				
10.4	6473	1.2	139.41	55.0							
11.3	5960	1.3	128.36	55.0							
12.5	5378	1.5	115.83	55.0							
13.9	4848	1.7	104.41	55.0							
15.1	4464	1.8	96.13	55.0							
16.8	4013	2.0	86.43	55.0							
18.3	3674	2.2	79.13	55.0							
20.3	3315	2.4	71.40	55.0							
23.0	2926	2.7	63.02	55.0							
24.5	2751	2.9	59.26	55.0							
27.0	2492	3.2	53.66	55.0							



P_1 [кВт]	n_2 [мин ⁻¹]	M_2 [Нм]	f_B	i	F_R [кН]	Редуктор		
7.50	14.1	4573	1.3	205.73	55.0	A903 - 132S/2C F903 - 132S/2C	223	103
	15.6	4126	1.5	185.64	55.0			
	18.8	3425	1.8	154.07	55.0			
	20.8	3099	1.9	139.41	55.0			
	22.6	2853	2.1	128.36	55.0			
	25.0	2575	2.3	115.83	55.0			
	27.8	2321	2.6	104.41	55.0			
	30.2	2137	2.8	96.13	55.0			
	33.6	1921	3.1	86.43	55.0			
	36.6	1759	3.4	79.13	55.0			
	40.6	1587	3.8	71.40	55.0			
	8.3	8210	1.0	115.83	55.0	A903 - 160M/6B F903 - 160M/6B	266	103
	9.2	7400	1.1	104.41	55.0			
	10.0	6813	1.2	96.13	55.0			
	11.1	6126	1.3	86.43	55.0			
	12.1	5608	1.4	79.13	55.0			
	13.4	5061	1.6	71.40	55.0			
	15.2	4467	1.8	63.02	55.0			
	16.2	4200	1.9	59.26	55.0			
17.9	3803	2.1	53.66	55.0				
19.8	3437	2.3	48.50	55.0				
9.20	181.1	446	1.3	16.01	9.6	A402 - 132M/2 F402 - 132M/2	90	89
	200.0	404	1.3	14.50	9.4			
	233.0	347	1.5	12.44	9.2			
	253.1	319	1.5	11.46	9.1			
	315.2	256	1.8	9.20	8.7			
	348.0	232	1.9	8.33	8.5			
	401.7	201	2.1	7.22	8.2			
	500.3	162	2.6	5.80	7.8			
	552.4	146	2.6	5.25	7.6			
	116.5	724	1.0	12.44	9.8			
	126.5	667	1.0	11.46	9.8			
	157.6	535	1.1	9.20	9.6			
	174.1	485	1.2	8.33	9.5			
	200.8	420	1.3	7.22	9.3			
	250.0	337	1.6	5.80	9.0			
	276.2	305	1.6	5.25	8.8			
	339.0	244	1.1	8.56	3.8	A501 - 132M/2 F501 - 132M/2	80	91
	381.6	216	1.2	7.60	3.7			
	470.3	176	1.5	6.17	3.4			
	516.4	160	1.5	5.62	3.3			
	612.7	135	1.8	4.73	3.2			
	714.5	116	2.1	4.06	3.1			
	767.6	108	2.2	3.78	3.0			
	878.8	94	2.5	3.30	2.9			
	1122.6	74	2.9	2.58	2.7			
	1475.4	56	3.1	1.97	2.6			
	1990.2	41	4.0	1.46	2.4			
	2189.8	38	4.0	1.32	2.3			
	235.0	363	0.9	6.17	4.0	A501 - 132M/4 F501 - 132M/4	80	91
	258.0	330	1.0	5.62	4.0			
	306.6	278	1.2	4.73	3.8			
	357.1	239	1.3	4.06	3.7			
	383.6	222	1.4	3.78	3.6			
	439.4	194	1.6	3.30	3.5			
	562.0	152	1.8	2.58	3.3			
	736.0	116	2.0	1.97	3.1			
	993.2	86	2.6	1.46	2.8			
	1098.5	78	2.6	1.32	2.7			
	74.0	1093	1.1	39.21	14.7			
	83.3	971	1.2	34.83	14.6			
	91.9	880	1.4	31.57	14.4			
	102.6	788	1.5	28.26	14.1			
107.5	752	1.6	26.98	14.0				
125.3	645	1.9	23.14	13.7				
133.7	605	2.0	21.69	13.5				
147.5	548	2.2	19.66	13.3				
154.2	524	2.1	18.81	13.1				
172.0	470	2.4	16.86	12.8				

P_1 [кВт]	n_2 [мин ⁻¹]	M_2 [Нм]	f_B	i	F_R [кН]	Редуктор					
9.20	191.7	422	2.7	15.13	12.5	A502 - 132M/2 F502 - 132M/2	107	93			
	211.6	382	2.7	13.71	12.3						
	258.8	312	2.6	11.20	11.7						
	321.9	251	2.7	9.01	11.0						
	355.2	228	2.6	8.16	10.8						
	384.2	210	2.9	7.55	10.5						
	477.8	169	3.1	6.07	9.9						
	527.2	153	3.4	5.50	9.7						
	51.3	1644	1.0	28.26	14.8				A502 - 132M/4 F502 - 132M/4	107	93
	53.7	1569	1.0	26.98	14.8						
	62.7	1346	1.2	23.14	14.7						
	66.9	1262	1.3	21.69	14.7						
	73.8	1144	1.4	19.66	14.6						
	77.1	1094	1.4	18.81	14.5						
	86.0	981	1.5	16.86	14.3						
	95.8	880	1.7	15.13	14.1						
	105.8	798	1.8	13.71	13.9						
	129.5	651	1.7	11.20	13.5						
	160.9	524	1.7	9.01	12.9						
	177.7	475	1.7	8.16	12.7						
	192.1	439	1.8	7.55	12.4						
	238.9	353	2.0	6.07	11.8						
	263.6	320	2.2	5.50	11.6						
	349.4	236	2.1	8.30	5.0	A601 - 132M/2 F601 - 132M/2	92	95			
	389.3	212	2.3	7.45	4.8						
	471.5	175	2.7	6.15	4.6						
	557.7	148	3.1	5.20	4.3						
	602.9	137	3.4	4.81	4.2						
	677.9	122	3.8	4.28	4.0						
	174.7	488	1.3	8.30	5.0	A601 - 132M/4 F601 - 132M/4	92	95			
	194.6	438	1.5	7.45	5.0						
	235.8	361	1.8	6.15	5.0						
	278.8	306	2.0	5.20	5.0						
	301.5	283	2.2	4.81	5.0						
	339.0	251	2.4	4.28	5.0						
	397.3	215	2.8	3.65	4.8						
	449.3	190	3.2	3.23	4.6						
	593.2	144	3.8	2.44	4.3						
	725.0	118	3.8	2.00	4.2						
	57.0	1419	1.7	50.91	22.0				A602 - 132M/2 F602 - 132M/2	135	97
	64.1	1262	2.0	45.27	22.0						
	71.1	1137	2.2	40.81	22.0						
76.3	1059	2.0	38.00	22.0							
85.8	942	2.5	33.79	21.8							
95.6	846	2.8	30.35	21.3							
102.3	790	3.1	28.36	21.0							
113.4	713	3.5	25.57	20.5							
122.6	660	3.8	23.66	20.1							
137.0	590	4.1	21.17	19.6							
28.5	2961	1.1	50.91	22.0	A602 - 132M/4 F602 - 132M/4	135	97				
32.0	2633	1.3	45.27	22.0							
35.5	2374	1.4	40.81	22.0							
38.2	2210	1.3	38.00	22.0							
42.9	1966	1.6	33.79	22.0							
47.8	1765	1.8	30.35	22.0							
51.1	1650	2.0	28.36	22.0							
56.7	1487	2.2	25.57	22.0							
61.3	1376	2.4	23.66	22.0							
68.5	1232	2.6	21.17	22.0							
74.0	1140	2.8	19.59	22.0							
82.4	1024	3.1	17.60	21.9							
91.4	923	3.5	15.87	21.4							
110.4	764	4.1	13.14	20.5							
34.4	2301	1.1	84.37	22.0	A603 - 132M/2 F603 - 132M/2	135	97				
36.3	2181	1.2	79.98	22.0							
41.5	1905	1.4	69.87	22.0							
52.0	1520	1.7	55.75	22.0							



P_1 [кВт]	n_2 [мин ⁻¹]	M_2 [Нм]	f_B	i	F_R [кН]	Редуктор			
9.20	26.0	3175	1.1	55.75	22.0	A603 - 132M/4 F603 - 132M/4	135	97	
	371.8 458.1	222 180	3.4 3.7	7.80 6.33	6.0 5.8	A701 - 132M/2 F701 - 132M/2	95	99	
	185.9 229.1 274.3 297.9 347.2 399.3	458 372 311 286 245 213	2.2 2.4 2.8 3.0 3.5 4.0	7.80 6.33 5.29 4.87 4.18 3.63	6.0 6.0 6.0 6.0 6.0 6.0	A701 - 132M/4 F701 - 132M/4	95	99	
	64.9 79.2 86.8	1245 1020 932	3.0 3.7 4.0	44.67 36.60 33.43	30.0 30.0 30.0	A702 - 132M/2 F702 - 132M/2	165	101	
	32.5 39.6 43.4 47.9 52.0 58.5 63.5	2598 2129 1945 1761 1621 1443 1328	1.9 2.3 2.6 2.8 3.1 3.5 3.8	44.67 36.60 33.43 30.27 27.87 24.80 22.84	30.0 30.0 30.0 30.0 30.0 30.0 30.0	A702 - 132M/4 F702 - 132M/4	165	101	
	22.6 24.4 26.7 28.9 32.2 34.8 39.3 43.1 52.0 63.5	3500 3238 2957 2737 2453 2273 2010 1835 1520 1245	1.1 1.2 1.3 1.4 1.5 1.7 1.9 2.0 2.5 3.0	128.35 118.75 108.46 100.38 89.95 83.35 73.70 67.31 55.75 45.67	30.0 30.0 30.0 30.0 30.0 30.0 30.0 30.0 30.0 30.0	A703 - 132M/2 F703 - 132M/2	165	101	
	16.1 17.4 19.7 21.5 26.0 31.7	5123 4747 4198 3834 3175 2601	1.0 1.1 1.2 1.3 1.6 1.9	89.95 83.35 73.70 67.31 55.75 45.67	30.0 30.0 30.0 30.0 30.0 30.0	A703 - 132M/4 F703 - 132M/4	165	101	
	14.1 15.6 18.8 20.8 22.6 25.0 27.8 30.2 33.6 36.6 40.6 46.0 48.9 54.0	5610 5062 4201 3801 3500 3158 2847 2621 2357 2158 1947 1718 1616 1463	1.1 1.2 1.4 1.6 1.7 1.9 2.1 2.3 2.5 2.8 3.1 3.5 3.7 4.1	205.73 185.64 154.07 139.41 128.36 115.83 104.41 96.13 86.43 79.13 71.40 63.02 59.26 53.66	55.0 55.0 55.0 55.0 55.0 55.0 55.0 55.0 55.0 55.0 55.0 54.4 53.5 52.1	A903 - 132M/2 F903 - 132M/2	227	103	
	10.4 11.3 12.5 13.9 15.1 16.8 18.3 20.3 23.0 24.5 27.0	7940 7311 6597 5947 5475 4923 4507 4067 3589 3375 3056	1.0 1.1 1.2 1.3 1.5 1.6 1.8 2.0 2.2 2.4 2.6	139.41 128.36 115.83 104.41 96.13 86.43 79.13 71.40 63.02 59.26 53.66	55.0 55.0 55.0 55.0 55.0 55.0 55.0 55.0 55.0 55.0 55.0	A903 - 132M/4 F903 - 132M/4	227	103	

P_1 [кВт]	n_2 [мин ⁻¹]	M_2 [Нм]	f_B	i	F_R [кН]	Редуктор		
11.0	315.2	307	1.5	9.20	8.4	A402 - 132M/2A F402 - 132M/2A	86	89
	348.0	278	1.6	8.33	8.2			
	401.7	241	1.7	7.22	7.6			
	500.3	193	2.1	5.80	7.5			
	174.0	580	1.0	8.33	8.9	A402 - 132M/4C F402 - 132M/4C	89	89
	200.9	502	1.1	7.22	8.8			
	250.1	403	1.4	5.80	8.6			
	276.2	365	1.4	5.25	8.5			
	470.3	210	1.2	6.17	3.4	A501 - 132M/2A F501 - 132M/2A	75	91
	516.4	191	1.3	5.62	3.3			
612.7	161	1.5	4.73	3.2				
714.5	138	1.7	4.06	3.1				
767.6	129	1.8	3.78	3.0				
878.8	112	2.1	3.30	2.9				
1122.6	88	2.4	2.58	2.7				
1475.4	67	2.6	1.97	2.5				
1990.2	50	3.3	1.46	2.3				
2189.8	45	3.3	1.32	2.2				
306.3	333	1.0	4.73	3.7	A501 - 132M/4C F501 - 132M/4C	78	91	
357.2	285	1.1	4.06	3.6				
383.8	265	1.2	3.78	3.6				
439.4	232	1.3	3.30	3.4				
561.3	182	1.5	2.58	3.2				
737.7	138	1.7	1.97	3.0				
995.1	102	2.1	1.46	2.8				
1094.9	93	2.1	1.32	2.7				
83.3	1161	1.0	34.83	13.7	A502 - 132M/2A F502 - 132M/2A	102	93	
91.9	1052	1.1	31.57	13.6				
102.6	942	1.3	28.26	13.4				
107.5	899	1.3	26.98	13.3				
125.3	771	1.6	23.14	13.1				
133.7	723	1.7	21.69	13.0				
147.5	655	1.8	19.66	12.8				
154.2	627	1.8	18.81	12.7				
172.0	562	2.0	16.86	12.4				
191.7	504	2.2	15.13	12.1				
211.6	457	2.3	13.71	11.9				
258.8	373	2.2	11.20	11.4				
321.9	300	2.2	9.01	10.8				
355.2	272	2.2	8.16	10.6				
384.2	252	2.4	7.55	10.3				
477.8	202	2.6	6.07	9.8				
527.2	183	2.9	5.50	9.5				
62.7	1609	1.0	23.14	13.5	A/F 502 - 132M/4C A/F 502 - 160M/4B	139	93	
66.9	1509	1.1	21.69	13.5				
73.8	1367	1.2	19.66	13.5				
77.1	1308	1.1	18.81	13.5				
86.0	1173	1.3	16.86	13.4				
95.8	1052	1.4	15.13	13.3				
105.8	954	1.5	13.71	13.2				
129.5	779	1.4	11.20	12.9				
160.9	627	1.4	9.01	12.4				
177.7	568	1.4	8.16	12.2				
192.1	525	1.5	7.55	12.0				
238.9	422	1.7	6.07	11.5				
263.6	383	1.8	5.50	11.3				
63.5	1589	0.9	15.13	13.4	A502 - 160L/6B F502 - 160L/6B	152	93	
70.0	1440	1.0	13.71	13.4				
85.7	1177	0.9	11.20	13.4				
106.5	947	1.0	9.01	13.2				
117.6	857	0.9	8.16	13.1				
127.2	793	1.0	7.55	12.9				
158.2	638	1.1	6.07	12.5				
174.5	578	1.2	5.50	12.3				



P_1 [кВт]	n_2 [мин ⁻¹]	M_2 [Нм]	f_B	i	F_R [кН]	Редуктор					
11.0	349.4	283	1.7	8.30	4.9	A601 - 132M/2A F601 - 132M/2A	87	95			
	389.3	254	1.9	7.45	4.8						
	471.5	209	2.3	6.15	4.6						
	557.7	177	2.6	5.20	4.3						
	602.9	164	2.8	4.81	4.2						
	677.6	146	3.1	4.28	4.0						
	794.5	124	3.6	3.65	3.9						
	898.6	110	4.1	3.23	3.9						
	174.7	583	1.1	8.30	5.0				A/F 601 - 132M/4C A/F 601 - 160M/4B	126	95
	194.6	524	1.2	7.45	5.0						
235.8	432	1.5	6.15	5.0							
278.8	365	1.7	5.20	5.0							
301.5	338	1.8	4.81	5.0							
338.8	301	2.0	4.28	4.9							
397.3	257	2.3	3.65	4.7							
449.3	227	2.6	3.23	4.6							
593.2	172	3.2	2.44	4.2							
725.0	141	3.2	2.00	4.0							
156.0	653	1.0	6.15	5.0	A601 - 160L/6B F601 - 160L/6B	139	95				
184.6	552	1.1	5.20	5.0							
199.5	511	1.2	4.81	5.0							
224.4	454	1.3	4.28	5.0							
263.0	387	1.5	3.65	5.0							
297.5	343	1.8	3.23	5.0							
392.7	259	2.1	2.44	4.7							
480.0	212	2.1	2.00	4.5							
693.3	147	3.1	1.38	4.0							
756.9	135	3.0	1.27	3.9							
57.0	1697	1.5	50.91	22.0	A602 - 132M/2A F602 - 132M/2A	130	97				
64.1	1509	1.6	45.27	22.0							
71.1	1360	1.8	40.81	21.8							
76.3	1266	1.7	38.00	21.5							
85.8	1126	2.1	33.79	21.1							
95.5	1011	2.4	30.35	20.6							
102.2	945	2.6	28.36	20.3							
113.4	852	2.9	25.57	19.9							
122.6	789	3.1	23.66	19.6							
137.0	706	3.4	21.17	19.1							
148.0	653	3.7	19.59	18.7							
164.7	587	4.1	17.60	18.3							
38.2	2643	1.1	38.00	22.0				A602 - 132M/4C F602 - 132M/4C	169	97	
32.0	3149	1.0	45.27	22.0	A/F 602 - 132M/4C A/F 602 - 160M/4B	169	97				
35.5	2838	1.2	40.81	22.0							
42.9	2350	1.4	33.79	22.0							
47.8	2111	1.5	30.35	22.0							
51.1	1972	1.7	28.36	22.0							
56.7	1778	1.9	25.57	22.0							
61.3	1646	2.0	23.66	22.0							
68.5	1472	2.2	21.17	21.7							
74.0	1362	2.3	19.59	21.4							
82.4	1224	2.6	17.60	21.1							
91.4	1104	2.9	15.87	20.7							
110.4	914	3.4	13.14	19.9							
132.9	759	4.0	10.91	19.1							
147.5	684	4.1	9.83	18.7							

P_1 [кВт]	n_2 [мин ⁻¹]	M_2 [Нм]	f_B	i	F_R [кН]	Редуктор		
11.0	31.6	3188	1.0	30.35	22.0	A602 - 160L/6B F602 - 160L/6B	182	97
	33.8	2980	1.1	28.36	22.0			
	37.5	2686	1.2	25.57	22.0			
	40.6	2486	1.3	23.66	22.0			
	45.3	2224	1.4	21.17	22.0			
	49.0	2058	1.6	19.59	22.0			
	54.5	1849	1.7	17.60	22.0			
	60.5	1667	1.9	15.87	22.0			
	73.1	1380	2.2	13.14	21.5			
	88.0	1146	2.6	10.91	20.9			
	97.6	1033	2.7	9.83	20.5			
	117.9	855	2.9	8.14	19.7			
	138.8	727	3.2	6.92	19.1			
	154.0	655	3.1	6.24	18.6			
	185.9	542	3.3	5.16	17.8			
	41.5	2278	1.2	69.87	22.0	A603 - 132M/2A F603 - 132M/2A	130	97
	52.0	1818	1.4	55.75	22.0			
	371.8	266	2.8	7.80	6.0	A701 - 132M/2A F701 - 132M/2A	90	99
	458.1	216	3.1	6.33	5.8			
	548.2	180	3.7	5.29	5.5			
	595.9	166	3.9	4.87	5.7			
	185.9	548	1.8	7.80	6.0	A/F 701 - 132M/4C A/F 701 - 160M/4B	128.5	99
	229.1	445	2.0	6.33	6.0			
	274.1	372	2.4	5.29	6.0			
	297.9	342	2.5	4.87	6.0			
	347.2	294	2.9	4.18	6.0			
	399.3	255	3.3	3.63	6.0			
	454.5	224	3.7	3.19	5.8			
	483.3	211	3.8	3.00	5.7			
	123.1	828	1.2	7.80	6.0	A701 - 160L/6B F701 - 160L/6B	129	99
	151.6	672	1.3	6.33	6.0			
	181.6	561	1.6	5.29	6.0			
	197.3	517	1.7	4.87	6.0			
	229.9	443	1.9	4.18	6.0			
	264.3	385	2.2	3.63	6.0			
	300.9	339	2.4	3.19	6.0			
	320.0	318	2.5	3.00	6.0			
	381.0	267	3.0	2.52	6.0			
	471.9	216	3.5	2.03	5.7			
	522.1	195	3.6	1.84	5.9			
	64.9	1489	2.5	44.67	30.0			
	79.2	1220	3.1	36.60	30.0			
	86.7	1114	3.4	33.43	30.0			
	95.8	1009	3.7	30.27	30.0			
	104.0	929	4.0	27.87	30.0			
	32.5	3107	1.6	44.67	30.0	A/F 702 - 132M/4C A/F 702 - 160M/4B	199	101
	39.6	2546	2.0	36.60	30.0			
	43.4	2325	2.2	33.43	30.0			
	47.9	2105	2.4	30.27	30.0			
	52.0	1939	2.6	27.87	30.0			
	58.5	1725	2.9	24.80	30.0			
	63.5	1588	3.1	22.84	30.0			
	69.5	1451	3.4	20.86	30.0			
	74.0	1363	3.7	19.60	30.0			
	84.4	1195	4.0	17.18	30.0			
	21.5	4693	1.1	44.67	30.0	A702 - 160L/6B F702 - 160L/6B	199	101
	26.2	3845	1.3	36.60	30.0			
	28.7	3512	1.4	33.43	30.0			
	31.7	3180	1.6	30.27	30.0			
	34.4	2928	1.7	27.87	30.0			
	38.7	2605	1.9	24.80	30.0			
	42.0	2399	2.1	22.84	30.0			
	46.0	2191	2.3	20.86	30.0			
	49.0	2059	2.4	19.60	30.0			
	55.9	1805	2.7	17.18	30.0			
	68.2	1479	3.1	14.08	30.0			
	74.7	1351	3.3	12.86	30.0			
	91.2	1106	3.6	10.53	30.0			

P_1 [кВт]	n_2 [мин ⁻¹]	M_2 [Нм]	f_B	i	F_R [кН]	Редуктор					
11.0	26.7	3536	1.1	108.46	30.0	A703 - 132M/2A F703 - 132M/2A	160	101			
	28.9	3272	1.1	100.38	30.0						
	32.2	2933	1.3	89.95	30.0						
	34.8	2717	1.4	83.35	30.0						
	39.3	2403	1.6	73.70	30.0						
	43.1	2194	1.7	67.31	30.0						
	52.0	1817	2.1	55.75	30.0						
	63.5	1489	2.5	45.67	30.0						
	19.7	5019	1.0	73.70	30.0	A/F 703 - 132M/4C A/F 703 - 160M/4B	199	101			
	21.5	4584	1.1	67.31	30.0						
	26.0	3797	1.3	55.75	30.0						
	31.7	3110	1.6	45.67	30.0						
	21.0	4798	1.0	45.67	30.0	A703 - 160L/6B F703 - 160L/6B	212	101			
	22.6	4462	1.8	42.47	55.0	A902 - 160L/6B F902 - 160L/6B	284	103			
	25.0	4026	2.0	38.33	55.0						
	30.2	3341	2.4	31.81	55.0						
	36.4	2771	2.9	26.38	55.0						
	40.3	2500	3.2	23.80	55.0						
	48.6	2075	3.9	19.75	52.8						
	34.1	2954	2.7	42.47	55.0	A902 - 160M/4B F902 - 160M/4B	266	103			
	37.8	2666	3.0	38.33	55.0						
	45.6	2212	3.6	31.81	53.3						
	18.8	5023	1.2	154.07	55.0	A903 - 132M/2A F903 - 132M/2A	237	103			
	20.8	4545	1.3	139.41	55.0						
	22.6	4185	1.4	128.36	55.0						
	25.0	3776	1.6	115.83	55.0						
	27.8	3404	1.8	104.41	55.0						
	30.2	3134	1.9	96.13	55.0						
33.6	2818	2.1	86.43	55.0							
36.6	2580	2.3	79.13	55.0							
40.6	2328	2.6	71.40	55.0							
46.0	2055	2.9	63.02	55.0							
48.9	1932	3.1	59.26	55.0							
54.0	1749	3.4	53.66	55.0							
12.5	7888	1.0	115.83	55.0	A/F 903 - 132M/4C A/F 903 - 160M/4B				266	103	
13.9	7110	1.1	104.41	55.0							
15.1	6547	1.2	96.13	55.0							
16.8	5886	1.4	86.43	55.0							
18.3	5389	1.5	79.13	55.0							
20.3	4862	1.6	71.40	55.0							
23.0	4292	1.9	63.02	55.0							
24.5	4036	2.0	59.26	55.0							
27.0	3654	2.2	53.66	55.0							
12.1	8226	1.0	79.13	55.0	A903 - 160L/6B F903 - 160L/6B	284	103				
13.4	7422	1.1	71.40	55.0							
15.2	6551	1.2	63.02	55.0							
16.2	6160	1.3	59.26	55.0							
17.9	5578	1.4	53.66	55.0							
19.8	5042	1.6	48.50	55.0							
29.9	3303	2.4	48.50	55.0	A903 - 160M/4B F903 - 160M/4B	266	103				
15.0	86.0	1599	0.9	16.86	11.4	A502 - 160L/4A F502 - 160L/4A	148	93			
	95.8	1435	1.0	15.13	11.6						
	105.8	1300	1.1	13.71	11.6						
	129.5	1062	1.0	11.20	11.6						
	160.9	855	1.1	9.01	11.4						
	177.7	774	1.0	8.16	11.3						
	192.1	716	1.1	7.55	11.2						
	238.9	576	1.2	6.07	10.8						
	263.6	522	1.3	5.50	10.6						

P_1 [кВт]	n_2 [мин ⁻¹]	M_2 [Нм]	f_B	i	F_R [кН]	Редуктор		
15.0	235.8	589	1.1	6.15	5.0	A601 - 160L/4A F601 - 160L/4A	135	95
	278.8	498	1.2	5.20	5.0			
	301.5	461	1.3	4.81	4.9			
	338.8	410	1.5	4.28	4.7			
	397.3	350	1.7	3.65	4.6			
	448.9	310	1.9	3.23	4.4			
	593.2	234	2.3	2.44	4.1			
	725.0	192	2.3	2.00	3.9			
	1047.2	133	3.4	1.38	3.5			
	1143.3	122	3.3	1.27	3.4			
	225.6	616	1.0	4.28	5.0	A601 - 180L/6A F601 - 180L/6A	167	95
	264.4	526	1.1	3.65	5.0			
	299.0	465	1.3	3.23	4.9			
	394.8	352	1.6	2.44	4.6			
	482.5	288	1.6	2.00	4.3			
	696.9	199	2.3	1.38	3.9			
	760.9	183	2.2	1.27	3.8			
		42.9	3205	1.0	33.79			
47.8		2878	1.1	30.35	19.6			
51.1		2690	1.2	28.36	19.6			
56.7		2425	1.4	25.57	19.7			
61.3		2244	1.5	23.66	19.7			
68.5		2008	1.6	21.17	19.6			
74.0		1858	1.7	19.59	19.5			
82.4		1669	1.9	17.60	19.3			
91.4		1505	2.1	15.87	19.1			
110.4		1246	2.5	13.14	18.6			
132.9		1035	2.9	10.91	18.0			
147.5		932	3.0	9.83	17.7			
178.1		772	3.2	8.14	17.0			
209.5		656	3.5	6.92	16.5			
232.4	592	3.4	6.24	16.1				
281.0	489	3.7	5.16	15.4				
	40.8	3372	1.0	23.66	19.0	A602 - 180L/6A F602 - 180L/6A	210	97
	45.6	3017	1.1	21.17	19.3			
	49.3	2792	1.1	19.59	19.5			
	54.8	2508	1.3	17.60	19.6			
	60.8	2262	1.4	15.87	19.6			
	73.4	1873	1.7	13.14	19.4			
	88.5	1555	1.9	10.91	19.1			
	98.2	1401	2.0	9.83	18.9			
	118.6	1160	2.2	8.14	18.4			
	139.5	986	2.3	6.92	18.0			
	154.6	889	2.2	6.24	17.6			
	187.0	735	2.4	5.16	17.0			
		185.9	747	1.3	7.80			
229.1		607	1.5	6.33	6.0			
274.1		507	1.7	5.29	6.0			
297.7		467	1.9	4.87	6.0			
346.9		401	2.1	4.18	6.0			
399.3		348	2.4	3.63	5.9			
454.5		306	2.7	3.19	5.7			
483.3		287	2.8	3.00	5.6			
575.4		241	3.3	2.52	5.3			
712.7		195	3.8	2.03	5.3			
788.6	176	4.0	1.84	5.1				
	152.4	912	1.0	6.33	6.0	A701 - 180L/6A F701 - 180L/6A	170	99
	182.6	761	1.2	5.29	6.0			
	198.3	701	1.2	4.87	6.0			
	231.1	601	1.4	4.18	6.0			
	265.7	523	1.6	3.63	6.0			
	302.5	459	1.8	3.19	6.0			
	321.7	432	1.9	3.00	6.0			
	382.9	363	2.2	2.52	6.0			
	474.3	293	2.6	2.03	5.6			
	524.8	265	2.6	1.84	5.5			
	668.1	208	3.4	1.44	5.1			
	768.1	181	3.6	1.26	5.2			

P_1 [кВт]	n_2 [мин ⁻¹]	M_2 [Нм]	f_B	i	F_R [кН]	Редуктор					
15.0	32.5	4237	1.2	44.67	30.0	A702 - 160L/4A F702 - 160L/4A	208	101			
	39.6	3471	1.4	36.60	30.0						
	43.4	3171	1.6	33.43	30.0						
	47.9	2871	1.7	30.27	30.0						
	52.0	2643	1.9	27.87	30.0						
	58.5	2352	2.1	24.80	30.0						
	63.5	2166	2.3	22.84	30.0						
	69.5	1978	2.5	20.86	30.0						
	74.0	1859	2.7	19.60	30.0						
	84.4	1630	2.9	17.18	30.0						
	103.0	1335	3.4	14.08	29.8						
	112.8	1219	3.6	12.86	29.2						
	137.7	999	4.0	10.53	27.8						
	26.4	5216	1.0	36.60	30.0				A702 - 180L/6A F702 - 180L/6A	240	101
	28.9	4764	1.0	33.43	30.0						
	31.9	4314	1.2	30.27	30.0						
	34.6	3972	1.3	27.87	30.0						
	38.9	3535	1.4	24.80	30.0						
	42.3	3254	1.5	22.84	30.0						
	46.3	2972	1.7	20.86	30.0						
	49.2	2793	1.8	19.60	30.0						
	56.2	2449	2.0	17.18	30.0						
	68.6	2006	2.3	14.08	30.0						
	75.1	1832	2.4	12.86	30.0						
	91.6	1501	2.7	10.53	30.0						
	111.8	1230	3.1	8.63	29.5						
	122.5	1123	3.3	7.88	28.8						
	134.1	1025	3.5	7.20	28.2						
	163.7	840	3.8	5.90	26.8						
	179.2	767	3.9	5.38	26.2						
	26.0	5177	1.0	55.75	30.0	A703 - 160L/4A F703 - 160L/4A	208	101			
	31.7	4241	1.2	45.67	30.0						
	34.1	4028	2.0	42.47	53.6	A902 - 160L/4A F902 - 160L/4A	284	103			
	37.8	3635	2.2	38.33	52.6						
	45.6	3017	2.7	31.81	50.7						
	55.0	2502	3.2	26.38	48.7						
60.9	2257	3.5	23.80	47.6							
22.7	6052	1.3	42.47	55.0	A902 - 180L/6A F902 - 180L/6A	305	103				
25.2	5462	1.5	38.33	55.0							
30.3	4533	1.8	31.81	54.8							
36.6	3759	2.1	26.38	53.1							
40.5	3392	2.4	23.80	52.2							
48.9	2815	2.8	19.75	50.3							
56.2	2448	3.2	17.18	48.8							
62.3	2209	3.5	15.50	47.7							
75.0	1833	4.0	12.86	45.7							
16.8	8026	1.0	86.43	55.0	A903 - 160L/4A F903 - 160L/4A	284	103				
18.3	7348	1.1	79.13	55.0							
20.3	6631	1.2	71.40	55.0							
23.0	5852	1.4	63.02	55.0							
24.5	5503	1.5	59.26	55.0							
27.0	4983	1.6	53.66	55.0							
29.9	4504	1.8	48.50	54.9							
16.3	8269	1.0	59.26	55.0				A903 - 180L/6A F903 - 180L/6A	305	103	
18.0	7488	1.1	53.66	55.0							
19.9	6768	1.2	48.50	55.0							
18.5	278.8	615	1.0	5.20	4.8	A601 - 180M/4B F601 - 180M/4B	171	95			
	301.5	568	1.1	4.81	4.8						
	338.8	506	1.2	4.28	4.6						
	397.3	431	1.4	3.65	4.5						
	448.9	382	1.6	3.23	4.3						
	594.3	288	1.9	2.44	4.0						
	725.0	236	1.9	2.00	3.8						
	1050.7	163	2.8	1.38	3.5						
	1141.7	150	2.7	1.27	3.4						

P_1 [кВт]	n_2 [мин ⁻¹]	M_2 [Нм]	f_B	i	F_R [кН]	Редуктор					
18.5	51.1	3317	1.0	28.36	17.1	A602 - 180M/4B F602 - 180M/4B	214	97			
	56.7	2991	1.1	25.57	17.4						
	61.3	2768	1.2	23.66	17.6						
	68.5	2476	1.3	21.17	17.7						
	74.0	2291	1.4	19.59	17.7						
	82.4	2059	1.6	17.60	17.7						
	91.4	1856	1.7	15.87	17.7						
	110.4	1537	2.0	13.14	17.4						
	132.9	1276	2.4	10.91	17.1						
	147.5	1150	2.4	9.83	16.8						
	178.1	952	2.6	8.14	16.3						
	209.5	809	2.8	6.92	15.8						
	232.4	730	2.7	6.24	15.5						
	281.0	604	3.0	5.16	14.9						
	185.9	922	1.1	7.80	6.0				A701 - 180M/4B F701 - 180M/4B	174	99
	229.1	748	1.2	6.33	6.0						
	274.1	625	1.4	5.29	6.0						
	297.7	576	1.5	4.87	6.0						
	346.9	494	1.7	4.18	6.0						
	399.4	429	2.0	3.63	5.9						
454.5	377	2.2	3.19	5.6							
483.3	355	2.3	3.00	5.5							
575.4	298	2.7	2.52	5.3							
712.7	240	3.1	2.03	4.9							
788.6	217	3.2	1.84	4.8							
199.3	860	1.0	4.87	6.0	A701 - 200L/6B F701 - 200L/6B	219	99				
232.3	738	1.2	4.18	6.0							
267.1	642	1.3	3.63	6.0							
304.0	564	1.5	3.19	6.0							
323.3	530	1.5	3.00	6.0							
384.9	445	1.8	2.52	5.9							
476.8	359	2.1	2.03	5.6							
527.5	325	2.2	1.84	5.4							
671.5	255	2.7	1.44	5.0							
772.0	222	2.9	1.26	4.8							
32.5	5225	1.0	44.67	30.0	A702 - 180M/4B F702 - 180M/4B	244	101				
39.6	4281	1.2	36.60	30.0							
43.4	3910	1.3	33.43	30.0							
47.9	3541	1.4	30.27	30.0							
52.0	3260	1.5	27.87	30.0							
58.5	2901	1.7	24.80	30.0							
63.5	2672	1.9	22.84	30.0							
69.5	2440	2.0	20.86	30.0							
74.0	2293	2.2	19.60	30.0							
84.4	2010	2.4	17.18	30.0							
103.0	1647	2.8	14.08	28.8							
112.8	1504	2.9	12.86	28.3							
137.7	1232	3.2	10.53	27.0							
168.0	1009	3.8	8.63	25.8							
184.0	922	4.0	7.88	25.2							
34.8	4873	1.0	27.87	30.0				A702 - 200L/6B F702 - 200L/6B	289	101	
42.5	3994	1.3	22.84	30.0							
46.5	3647	1.4	20.86	30.0							
49.5	3427	1.5	19.60	30.0							
56.5	3004	1.6	17.18	30.0							
68.9	2462	1.9	14.08	30.0							
75.4	2249	2.0	12.86	30.0							
92.1	1841	2.2	10.53	29.6							
112.4	1509	2.5	8.63	28.5							
123.1	1378	2.7	7.88	27.9							
134.7	1259	2.9	7.20	27.4							
164.4	1032	3.1	5.90	26.1							
180.3	941	3.2	5.38	25.6							
31.7	5231	1.0	45.67	30.0	A703 - 180M/4B F703 - 180M/4B	244	101				

P_1 [кВт]	n_2 [мин ⁻¹]	M_2 [Нм]	f_B	i	F_R [кН]	Редуктор				
18.5	34.1	4968	1.6	42.47	50.6	A902 - 180M/4B F902 - 180M/4B	309	103		
	37.8	4483	1.8	38.33	49.9					
	45.6	3721	2.2	31.81	48.5					
	55.0	3085	2.6	26.38	46.9					
	60.9	2784	2.9	23.80	46.0					
	73.4	2310	3.5	19.75	44.2					
	84.4	2009	3.9	17.18	42.8					
	22.8	7427	1.1	42.47	52.1	A902 - 200L/6B F902 - 200L/6B	360	103		
	25.3	6701	1.2	38.33	51.9					
	30.5	5562	1.4	31.81	51.3					
	36.8	4612	1.7	26.38	50.3					
	40.8	4162	1.9	23.80	49.6					
	49.1	3454	2.3	19.75	48.1					
	56.5	3004	2.6	17.18	46.9					
	62.6	2710	2.9	15.50	46.0					
	75.4	2249	3.2	12.86	44.3					
	94.4	1797	4.0	10.28	42.1					
	104.6	1622	4.0	9.28	41.1					
	126.0	1346	3.9	7.70	39.2					
	140.8	1205	4.2	6.89	38.2					
	20.3	8178	1.0	71.40	52.9	A903 - 180M/4B F903 - 180M/4B	309	103		
23.0	7218	1.1	63.02	52.7						
24.5	6787	1.2	59.26	52.6						
27.0	6146	1.3	53.66	52.2						
29.9	5555	1.4	48.50	51.7						
22.0	398.6	511	1.2	3.65	4.4	A601 - 180L/4B F601 - 180L/4B	179	95		
	450.8	452	1.3	3.23	4.2					
	596.3	342	1.6	2.44	4.0					
	727.5	280	1.6	2.00	3.8					
	1054.3	193	2.3	1.38	3.4					
	1145.7	178	2.2	1.27	3.3					
	61.5	3280	1.0	23.66	15.5	A602 - 180L/4B F602 - 180L/4B	222	97		
	68.7	2935	1.1	21.17	15.8					
	74.3	2716	1.2	19.59	16.0					
	82.7	2440	1.3	17.60	16.2					
	91.7	2200	1.5	15.87	16.3					
	110.7	1822	1.7	13.14	16.3					
	133.4	1512	2.0	10.91	16.1					
	148.0	1363	2.1	9.83	16.0					
	178.7	1128	2.2	8.14	15.6					
	210.3	959	2.4	6.92	15.2					
	233.2	865	2.3	6.24	15.0					
	282.0	715	2.5	5.16	14.5					
	229.9	887	1.0	6.33	6.0				A701 - 180L/4B F701 - 180L/4B	182
	275.0	741	1.2	5.29	6.0					
	298.8	682	1.3	4.87	6.0					
	348.1	585	1.5	4.18	6.0					
	400.8	508	1.7	3.63	5.8					
	456.1	447	1.8	3.19	5.6					
	485.0	420	1.9	3.00	5.5					
	577.4	353	2.3	2.52	5.2					
	716.7	284	2.6	2.03	4.9					
790.8	258	2.7	1.84	4.8						
1007.3	202	3.5	1.44	4.4						
1158.1	176	3.7	1.26	4.2						
232.3	877	1.0	4.18	6.0	A701 - 200L/6C F701 - 200L/6C	229	99			
267.1	763	1.1	3.63	6.0						
304.0	670	1.2	3.19	6.0						
323.3	630	1.3	3.00	6.0						
384.9	529	1.5	2.52	5.8						
476.8	427	1.8	2.03	5.5						
527.5	386	1.8	1.84	5.3						
671.5	303	2.3	1.44	5.0						
772.0	264	2.5	1.26	4.8						

P_1 [кВт]	n_2 [мин ⁻¹]	M_2 [Нм]	f_B	i	F_R [кН]	Редуктор						
22.0	39.8	5074	1.0	36.60	30.0	A702 - 180L/4B F702 - 180L/4B	252	101				
	43.5	4634	1.1	33.43	30.0							
	48.1	4196	1.2	30.27	30.0							
	52.2	3863	1.3	27.87	30.0							
	58.7	3438	1.5	24.80	29.9							
	63.7	3166	1.6	22.84	29.7							
	69.8	2892	1.7	20.86	29.4							
	74.2	2717	1.8	19.60	29.2							
	84.7	2382	2.0	17.18	28.7							
	103.3	1952	2.4	14.08	27.8							
	113.1	1783	2.5	12.86	27.3							
	138.2	1460	2.7	10.53	26.3							
	168.6	1196	3.2	8.63	25.2							
	184.6	1092	3.4	7.88	24.7							
	202.1	998	3.6	7.20	24.1							
246.6	818	3.9	5.90	23.0								
270.4	746	4.0	5.38	22.4								
22.0	42.5	4749	1.1	22.84	30.0	A702 - 200L/6C F702 - 200L/6C	299	101				
	46.5	4338	1.2	20.86	30.0							
	49.5	4076	1.2	19.60	30.0							
	56.5	3572	1.3	17.18	30.0							
	68.9	2928	1.6	14.08	29.5							
	75.4	2674	1.6	12.86	29.2							
	92.1	2190	1.8	10.53	28.4							
	112.4	1794	2.1	8.63	27.5							
	123.1	1639	2.3	7.88	27.0							
	134.7	1497	2.4	7.20	26.5							
	164.4	1227	2.6	5.90	25.5							
	180.3	1119	2.7	5.38	25.0							
	22.0	34.3	5888	1.4	42.47				47.7	A902 - 180L/4B F902 - 180L/4B	317	103
		38.0	5313	1.5	38.33				47.3			
		45.7	4410	1.8	31.81				46.3			
55.2		3657	2.2	26.38	45.1							
61.1		3299	2.4	23.80	44.3							
73.7		2738	2.9	19.75	42.8							
84.7		2381	3.3	17.18	41.6							
93.9		2149	3.6	15.50	40.7							
113.1		1783	4.1	12.86	39.1							
22.0		25.3	7970	1.0	38.33	47.3	A902 - 200L/6C F902 - 200L/6C	370	103			
	30.5	6614	1.2	31.81	46.3							
	36.8	5485	1.5	26.38	45.1							
	40.8	4949	1.6	23.80	44.3							
	49.1	4107	1.9	19.75	46.0							
	56.5	3572	2.2	17.18	45.1							
	62.6	3223	2.4	15.50	44.3							
	75.4	2675	2.7	12.86	42.9							
	94.4	2137	3.4	10.28	41.0							
	104.6	1929	3.4	9.28	40.1							
	126.0	1601	3.3	7.70	38.4							
	140.8	1433	3.5	6.89	37.4							
	156.0	1293	3.8	6.22	36.5							
	22.0	23.1	8554	0.9	63.02	48.5				A903 - 180L/4B F903 - 180L/4B	317	103
		24.6	8044	1.0	59.26	48.6						
27.1		7284	1.1	53.66	48.6							
30.0		6583	1.2	48.50	48.4							
30.0	299.8	927	0.9	4.87	6.0	A701 - 200L/4C F701 - 200L/4C	240	99				
	349.3	796	1.1	4.18	5.8							
	402.2	691	1.2	3.63	5.6							
	457.7	607	1.4	3.19	5.4							
	486.7	571	1.4	3.00	5.3							
	579.4	480	1.7	2.52	5.1							
	719.2	386	1.9	2.03	4.8							
	793.5	350	2.0	1.84	4.7							
	1013.9	274	2.6	1.44	4.3							
	1158.7	240	2.7	1.26	4.2							

P_1 [кВт]	n_2 [мин ⁻¹]	M_2 [Нм]	f_B	i	F_R [кН]	Редуктор						
30.0	52.4	5250	1.0	27.87	25.5	A702 - 200L/4C F702 - 200L/4C	310	101				
	63.9	4303	1.2	22.84	25.9							
	70.0	3930	1.3	20.86	26.0							
	74.5	3692	1.4	19.60	26.0							
	85.0	3236	1.5	17.18	25.8							
	103.7	2652	1.7	14.08	25.5							
	113.5	2423	1.8	12.86	25.2							
	138.7	1984	2.0	10.53	24.5							
	169.2	1626	2.3	8.63	23.7							
	185.3	1484	2.5	7.88	23.3							
	202.8	1356	2.7	7.20	22.9							
	247.5	1111	2.9	5.90	22.0							
	271.4	1014	3.0	5.38	21.5							
	34.4	8001	1.0	42.47	40.9				A902 - 200L/4C F902 - 200L/4C	381	103	
	38.1	7221	1.1	38.33	41.2							
	45.9	5992	1.3	31.81	41.3							
	55.3	4970	1.6	26.38	40.9							
	61.3	4484	1.8	23.80	40.5							
	73.9	3721	2.2	19.75	39.7							
	85.0	3236	2.4	17.18	38.9							
94.2	2920	2.7	15.50	38.3								
113.5	2423	3.0	12.86	37.0								
142.0	1936	3.7	10.28	35.4								
157.4	1747	3.7	9.28	34.6								
189.7	1450	3.7	7.70	33.1								
211.9	1298	3.9	6.89	32.3								
234.8	1171	4.2	6.22	31.5								
37.0	45.9	7391	1.1	31.81	36.8	A902 - 225S/4A F902 - 225S/4A	431	103				
	55.3	6129	1.3	26.38	37.2							
	61.3	5530	1.4	23.80	37.2							
	73.9	4589	1.7	19.75	36.9							
	85.0	3992	2.0	17.18	36.5							
	94.2	3601	2.2	15.50	36.1							
	113.5	2988	2.4	12.86	35.2							
	142.0	2388	3.0	10.28	33.9							
	157.3	2156	3.0	9.28	33.3							
	189.6	1789	3.0	7.70	32.1							
	211.9	1601	3.1	6.89	31.3							
	234.7	1445	3.4	6.22	30.6							
	282.9	1199	3.8	5.16	29.3							
	45.0	55.3	7454	1.1	26.38				33.0	A902 - 225M/4C F902 - 225M/4C	468	103
61.3		6725	1.2	23.80	33.4							
73.9		5581	1.4	19.75	33.8							
85.0		4855	1.6	17.18	33.8							
94.2		4380	1.8	15.50	33.6							
113.5		3634	2.0	12.86	33.2							
142.0		2905	2.5	10.28	32.3							
157.3		2622	2.5	9.28	31.8							
189.6		2176	2.4	7.70	30.8							
211.9		1947	2.6	6.89	30.2							
234.7		1758	2.8	6.22	29.6							
282.9		1458	3.2	5.16	28.5							

A 202

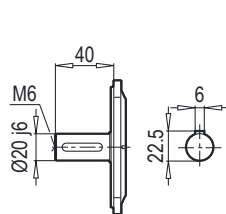
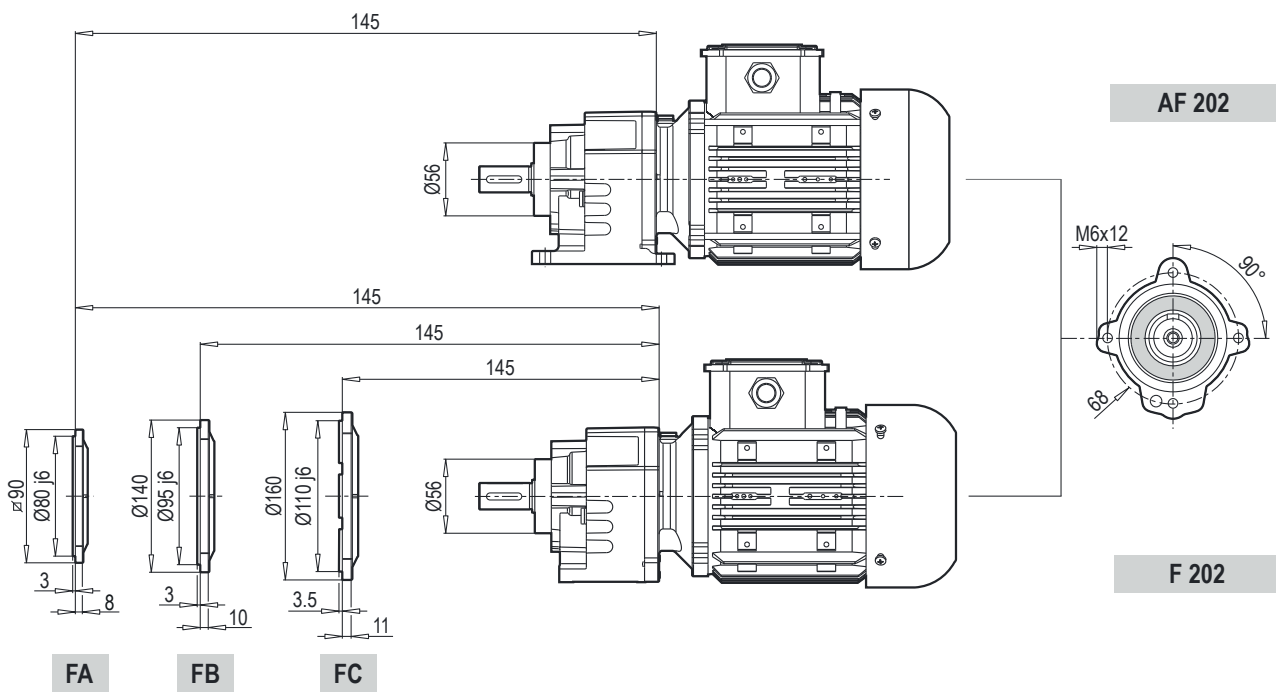
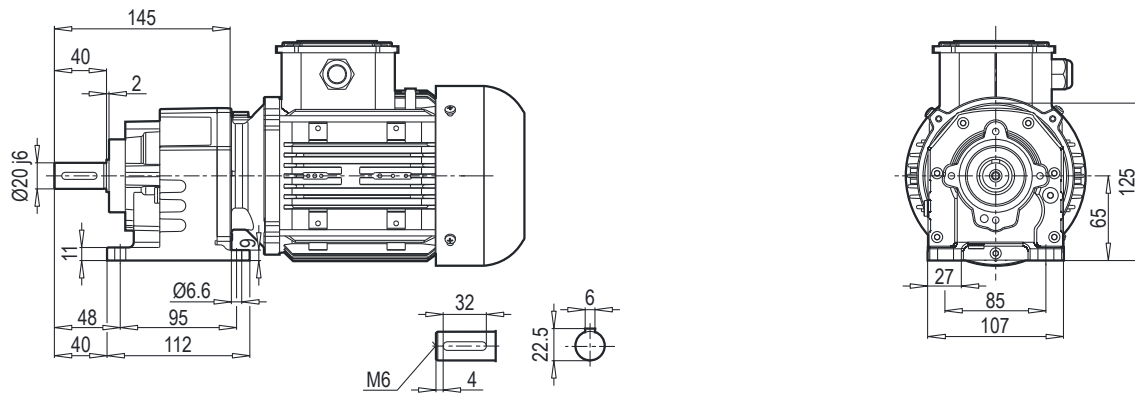

(A/F 202 - F202) FA

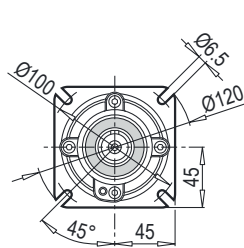

(F202) FB

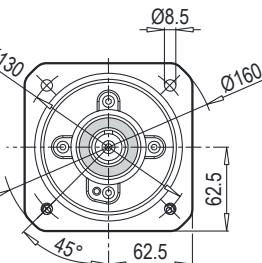
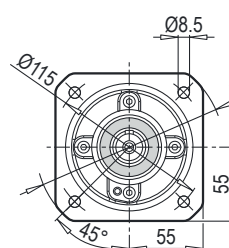

(F202) FC

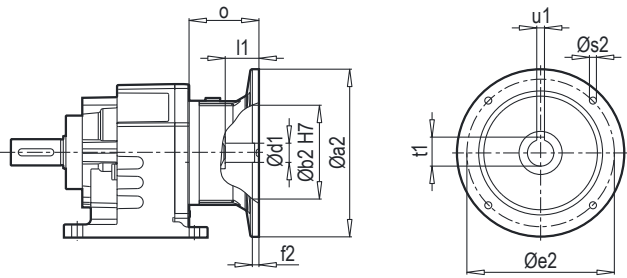
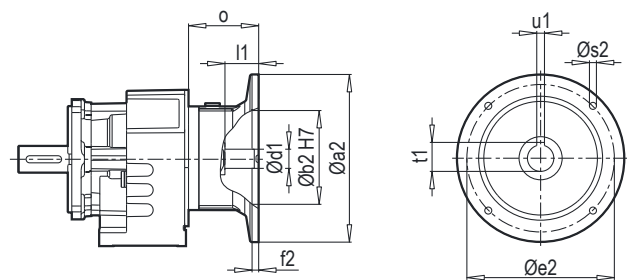
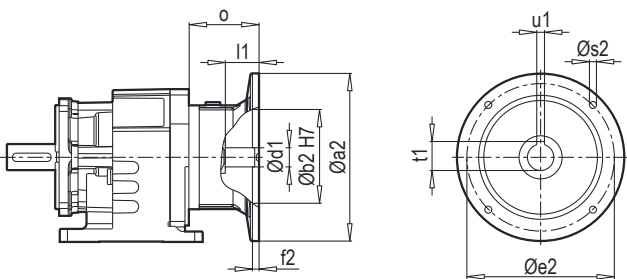
A 202 PAM B5/B14

F 202 PAM B5/B14

AF 202 PAM B5/B14

Редуктор	PAM B5	Øa2	Øb2	Øe2	f2	Øs2	Ød1	l1	t1	u1	o
A/F 202	56	120	80	100	3.5	M6	9	20	10.2	3	29.5
	63	140	95	115	3.5	M8	11	23	12.8	4	59.5

~ Kr	
PAM B5	A/F 202
56	5
63	5

Редуктор	PAM B14	Øa2	Øb2	Øe2	f2	Øs2	Ød1	l1	t1	u1	o
A/F 202	56	80	50	65	3	6	9	20	10.4	3	32.5
	63	90	60	75	2.5	6	11	23	12.8	4	59.5
	71	105	70	85	2.5	7	14	30	16.3	5	59.5

~ Kr	
PAM B14	A/F 202
56	4
63	4
71	5

A 202 G

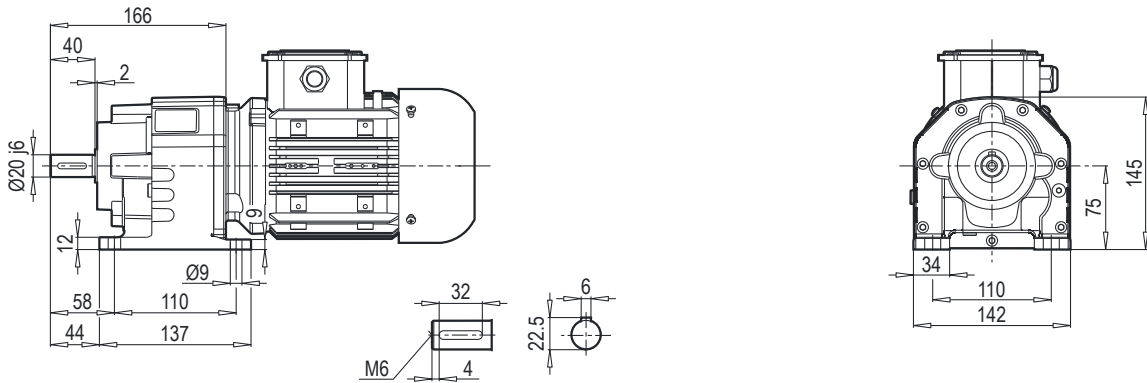

AF 202 G

F 202 G

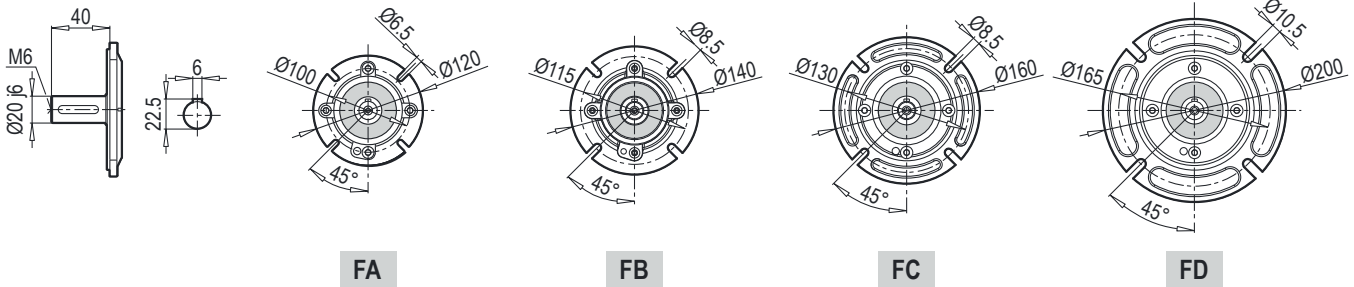
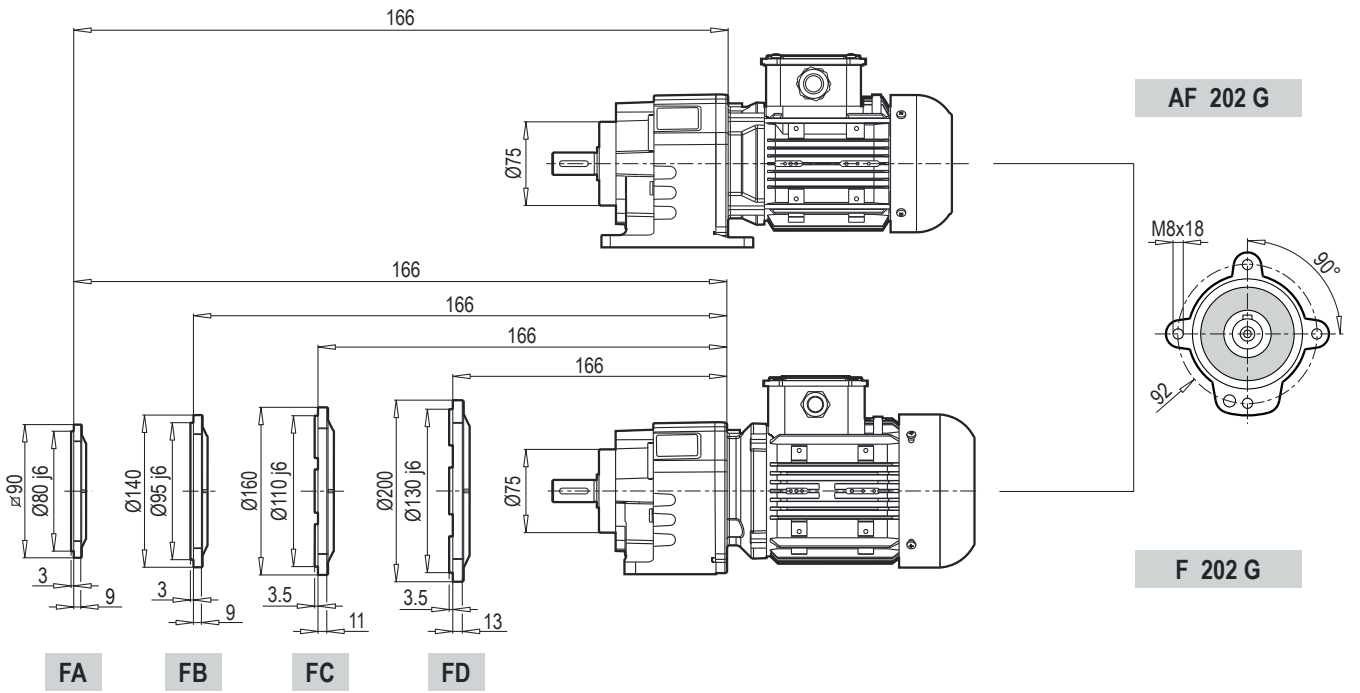

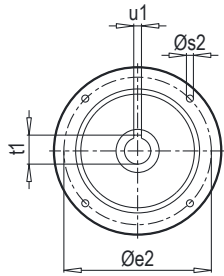
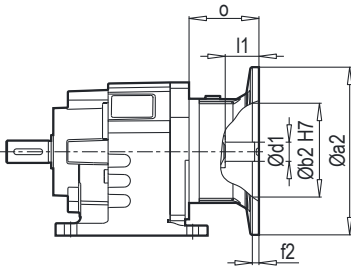
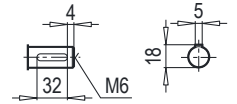
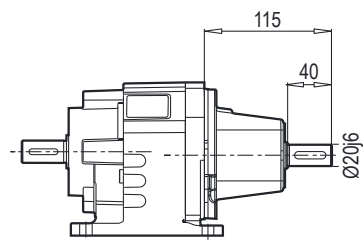
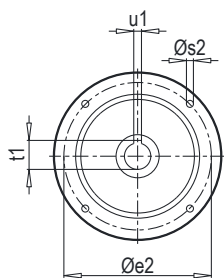
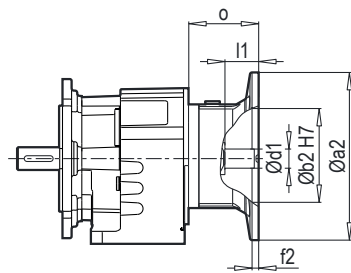
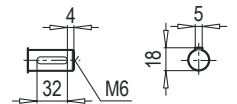
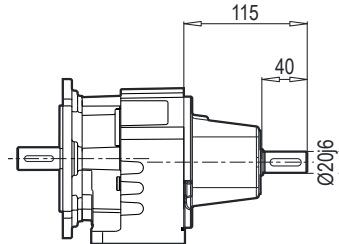
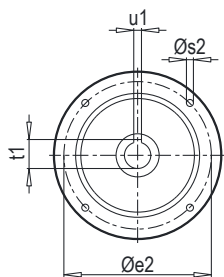
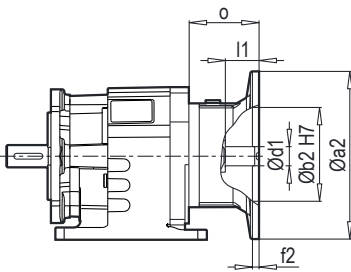
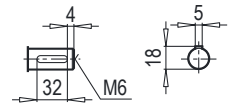
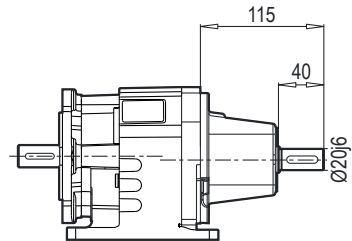
A 202 G PAM B5/B14

A 202 G W

F 202 G PAM B5/B14

F 202 G W

AF 202 G PAM B5/B14

AF 202 G W

Редуктор	PAM B5	Øa2	Øb2	Øe2	f2	Øs2	Ød1	l1	t1	u1	o
A/F 202 G	56	120	80	100	3.5	M6	9	20	10.2	3	29.5
	63	140	95	115	3.5	M8	11	23	12.8	4	74.5
	71	160	110	130	4	M8	14	30	16.3	5	74.5
	80	200	130	165	4	M10	19	40	21.8	6	74.5
	90	200	130	165	4	M10	24	50	27.3	8	87.5

~ Kr	
PAM B5	A/F 202 G
56	8
63	8
71	8
80	8
90	8

Редуктор	PAM B14	Øa2	Øb2	Øe2	f2	Øs2	Ød1	l1	t1	u1	o
A/F 202 G	56	80	50	65	3	6	9	20	10.4	3	32.5
	63	90	60	75	2.5	6	11	23	12.8	4	74.5
	71	105	70	85	2.5	7	14	30	16.3	5	74.5
	80	120	80	100	3	7	19	40	21.8	6	74.5
	90	140	95	115	3	9	24	50	27.3	8	87.5

~ Kr	
PAM B14	A/F 202 G
56	6
63	6
71	7
80	8
90	8

A 252-253

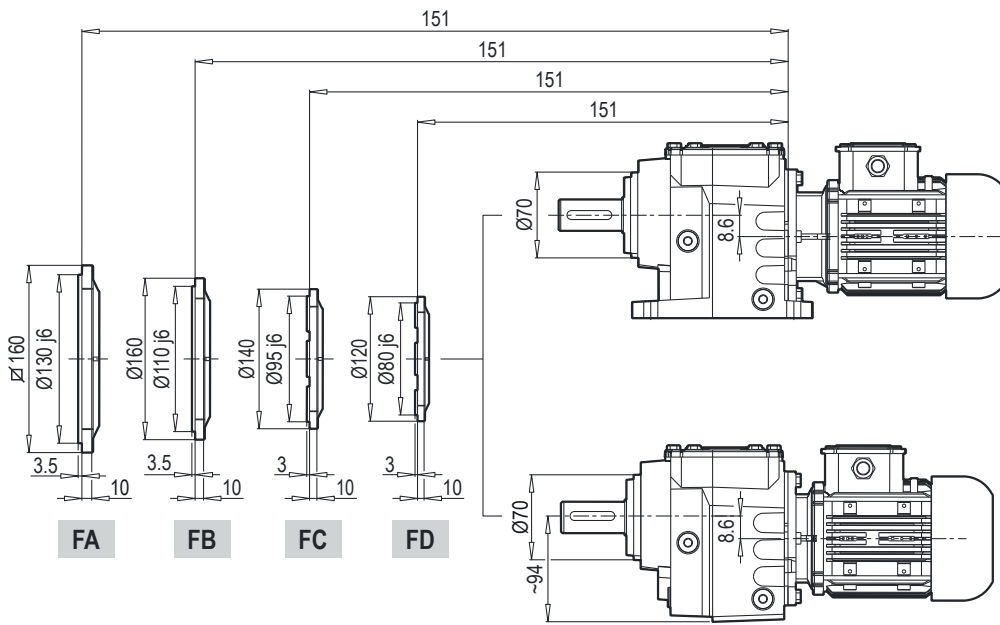
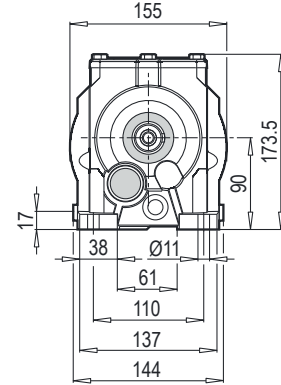
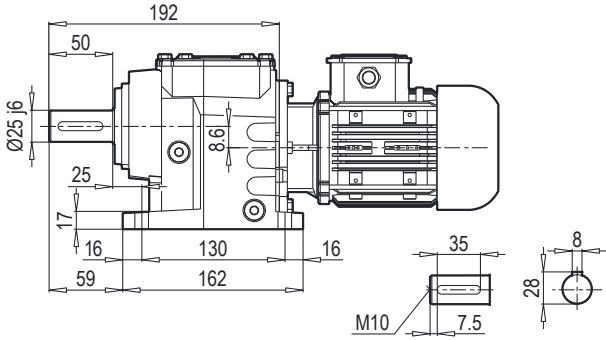

AF 252-253

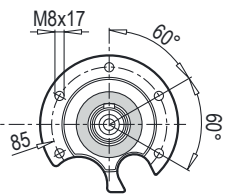

F 252-253

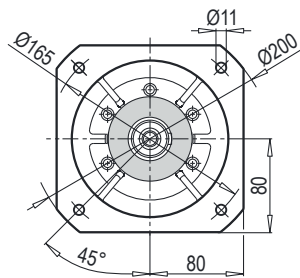
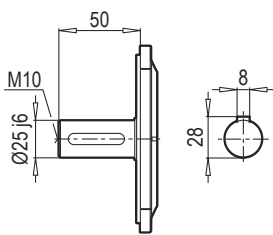

FA

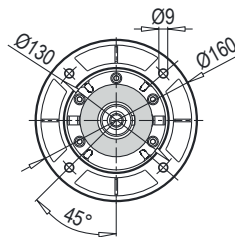

FB

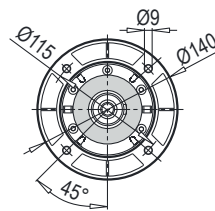

FC

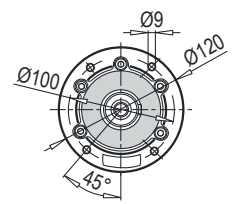

FD

A 252-253 PAM B5/B14

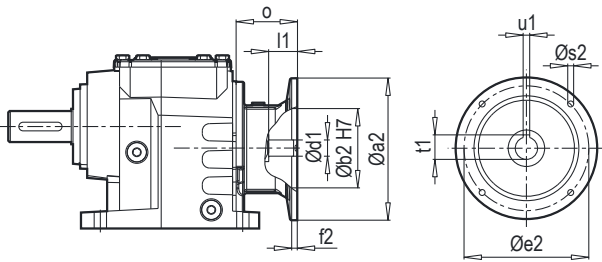

A 252-253 W

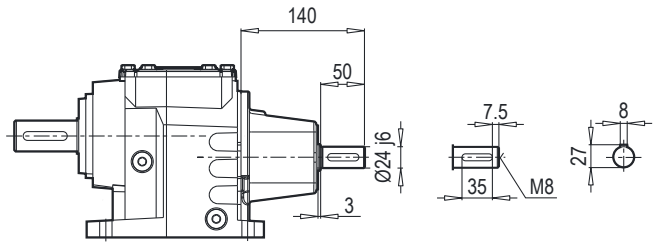

F 252-253 PAM B5/B14

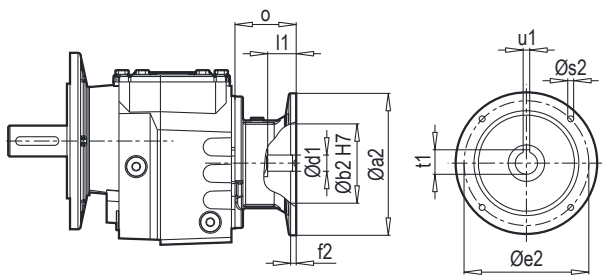

F 252-253 W

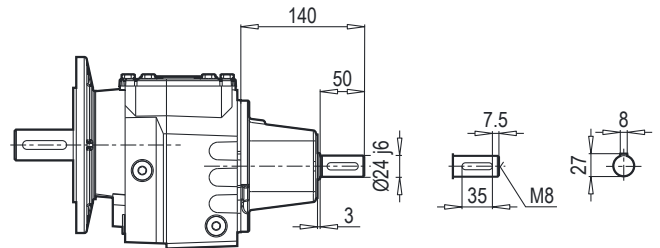

AF 252-253 PAM B5/B14

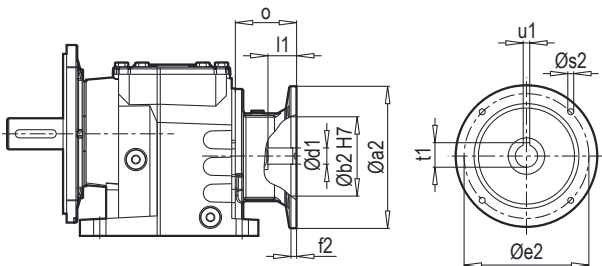

AF 252-253 W

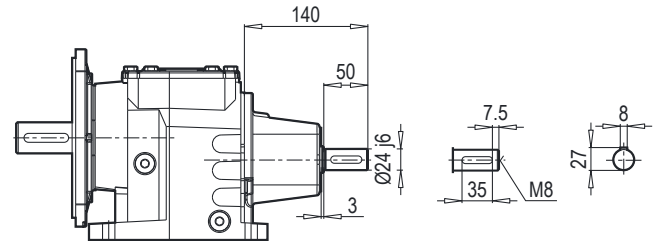

W ~ $\frac{kr}{kr}$	
A/F 252 - 253	14

Редуктор	PAM B5	Øa2	Øb2	Øe2	f2	Øs2	Ød1	l1	t1	u1	o
A/F 252 A/F 253	63	140	95	115	4.5	M8	11	25	12.8	4	57
	71	160	110	130	5	M8	14	32	16.3	5	69
	80	200	130	165	5	M10	19	42	21.8	6	90
	90	200	130	165	5	M10	24	52	27.3	8	90
	100	250	180	215	5.5	M12	28	62	31.3	8	105
	112	250	180	215	5.5	M12	28	62	31.3	8	105

~ $\frac{kr}{kr}$	
PAM B5	A/F 252 - 253
63	12
71	13
80	14
90	14
100	18
112	18

Редуктор	PAM B14	Øa2	Øb2	Øe2	f2	Øs2	Ød1	l1	t1	u1	o
A/F 252 A/F 253	63	90	60	75	2.5	6	11	25	12.8	4	57
	71	105	70	85	2.5	7	14	32	16.3	5	69
	80	120	80	100	3	7	19	42	21.8	6	90
	90	140	95	115	3	9	24	52	27.3	8	90
	100	160	110	130	3.5	9	28	62	31.3	8	105
	112	160	110	130	3.5	9	28	62	31.3	8	105

~ $\frac{kr}{kr}$	
PAM B14	A/F 252 - 253
63	11
71	12
80	13
90	13
100	14
112	14

A 301

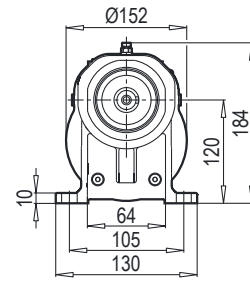
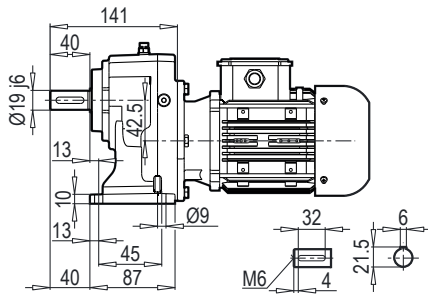

AF-M 301

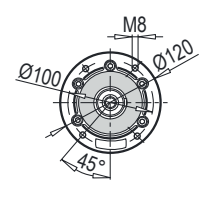
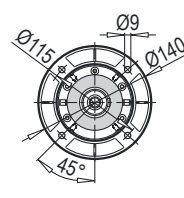
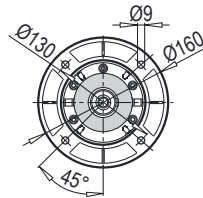
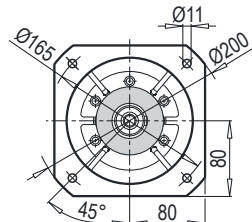
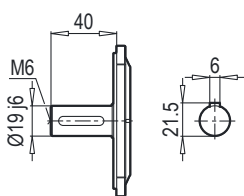
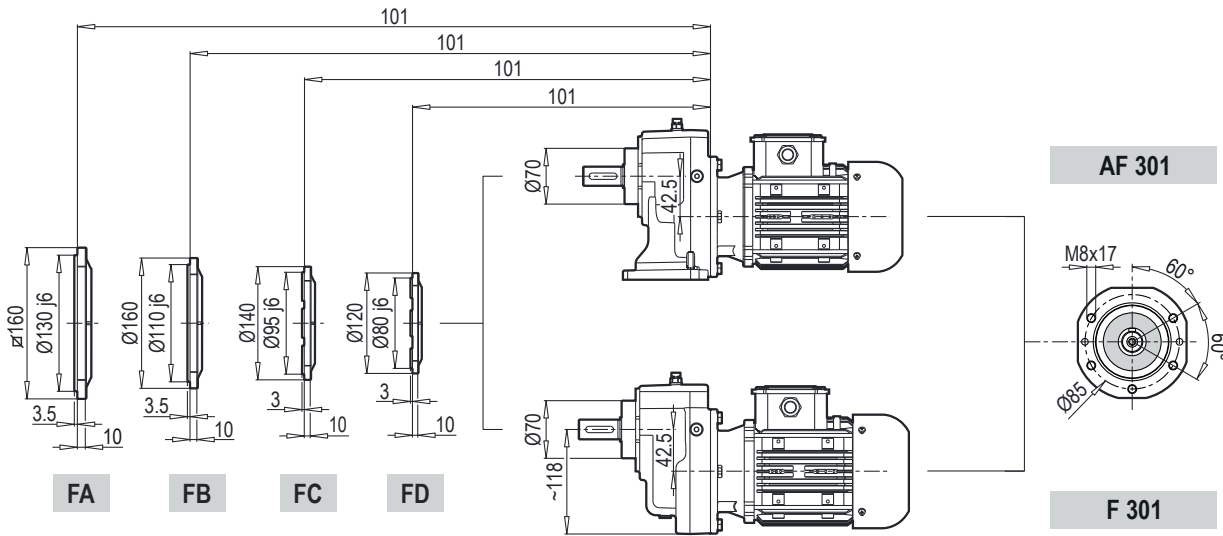
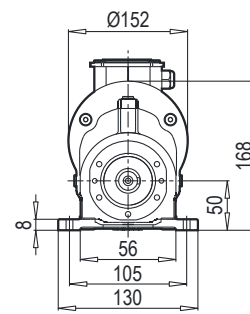
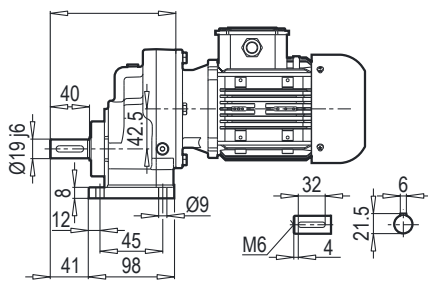

FA

FB

FC

FD

A 301 PAM B5/B14

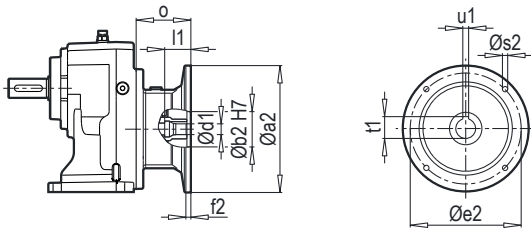

A 301 W

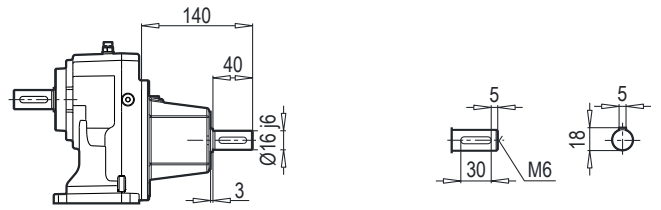

F 301 PAM B5/B14

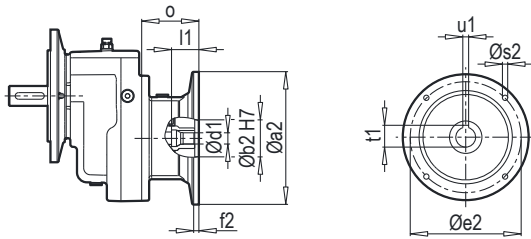

F 301 W

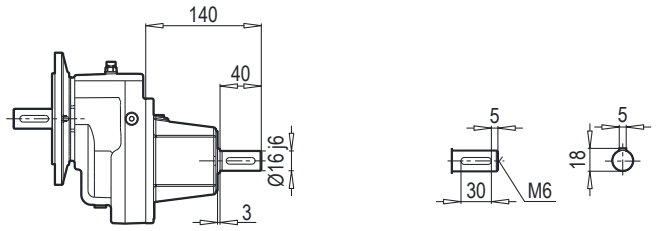

AF 301 PAM B5/B14

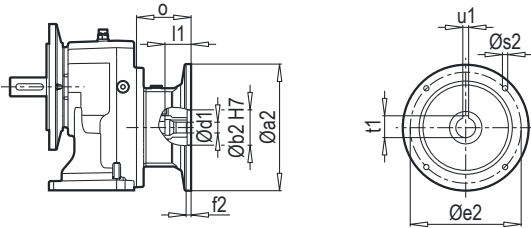

AF 301 W

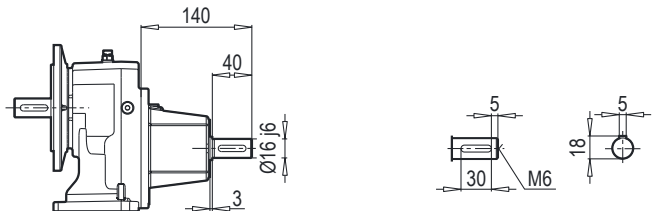

W ~ Kr	
A/F 301	10

AF-M 301 PAM B5/B14

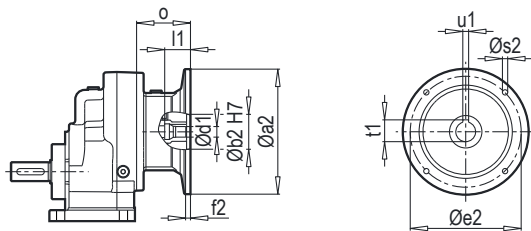

AF-M 301 W

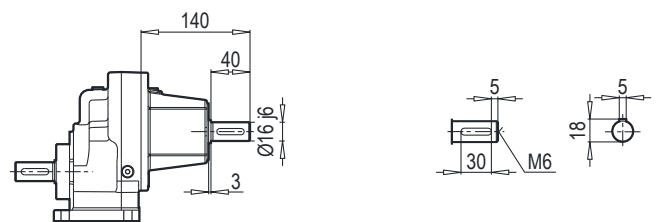

Редуктор	PAM B5	Øa2	Øb2	Øe2	f2	Øs2	Ød1	l1	t1	u1	o
A/F 301	71	160	110	130	5	M8	14	32	16.3	5	69
	80	200	130	165	5	M10	19	42	21.8	6	90
	90	200	130	165	5	M10	24	52	27.3	8	90

~ Kr	
PAM B5	A/F 301
71	6
80	6.5
90	6.5

Редуктор	PAM B14	Øa2	Øb2	Øe2	f2	Øs2	Ød1	l1	t1	u1	o
A/F 301	63	90	60	75	2.5	6	11	32	16.3	5	69
	71	105	70	85	2.5	7	14	42	21.8	6	90
	80	120	80	100	3	7	19	52	27.3	8	90

~ Kr	
PAM B14	A/F 301
63	5
71	5.5
80	5.5

A 302-303

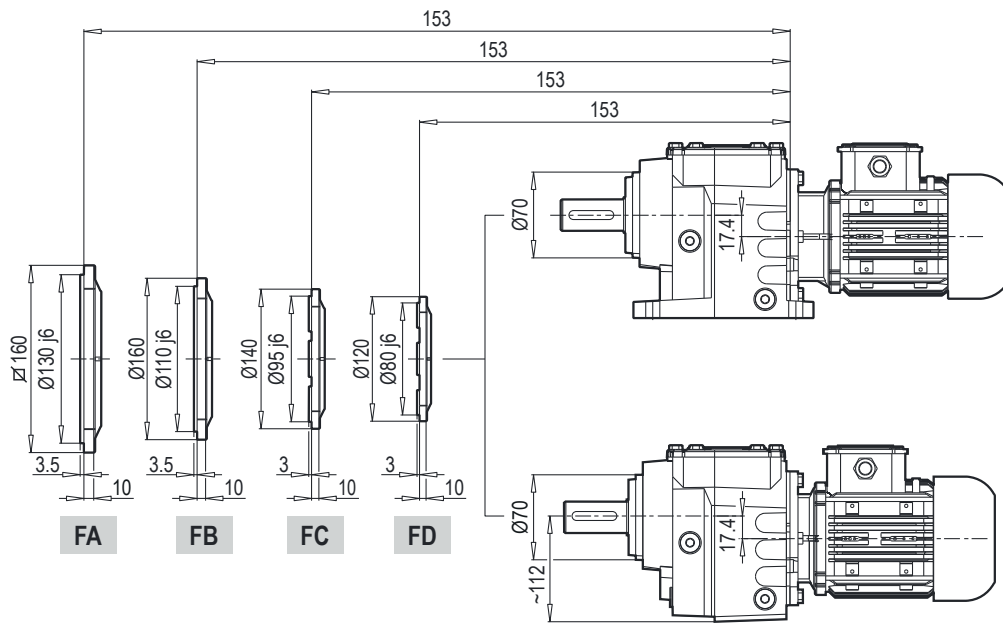
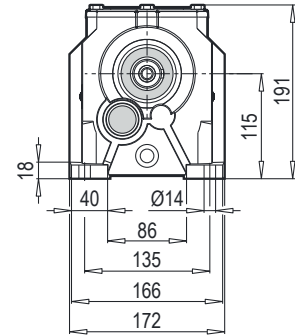
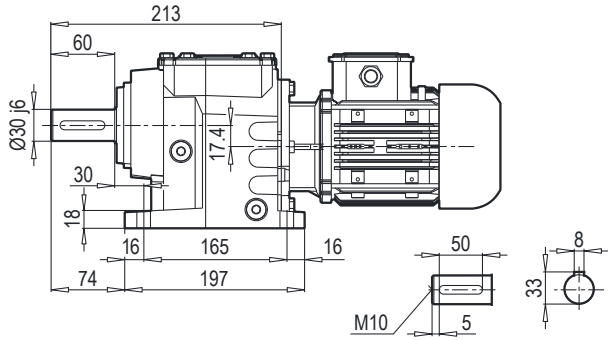

AF 302-303

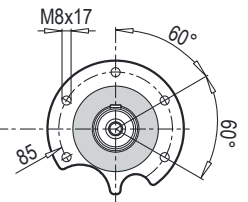

F 302-303

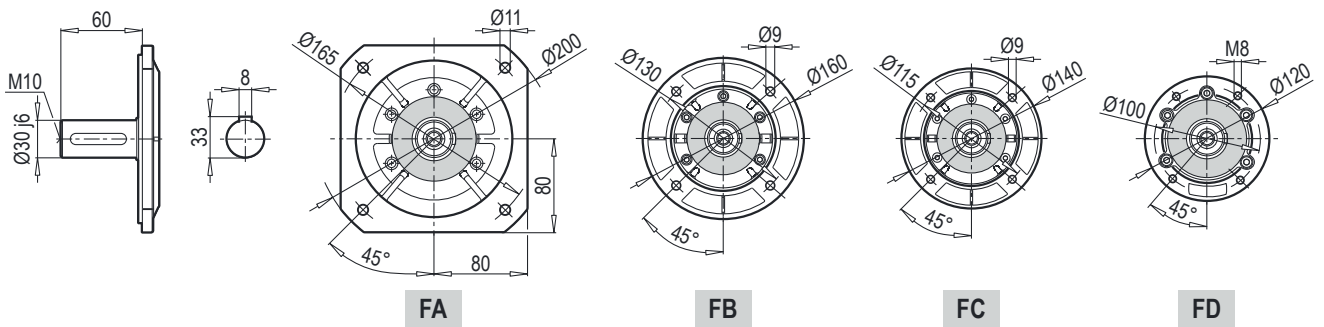

A 302-303 PAM B5/B14

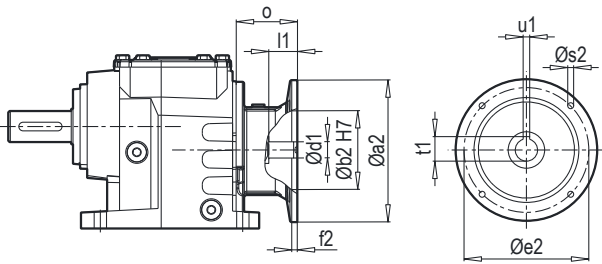

A 302-303 W

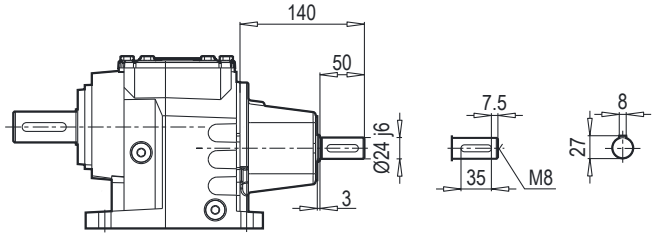

F 302-303 PAM B5/B14

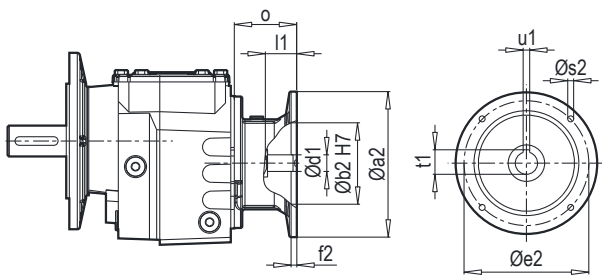

F 302-303 W

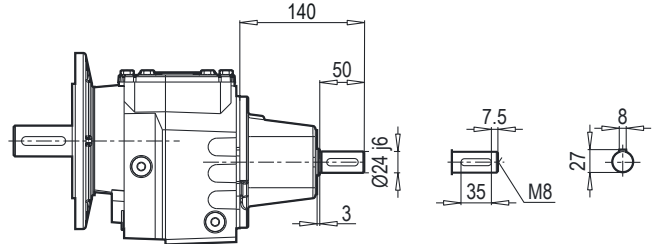

AF 302-303 PAM B5/B14

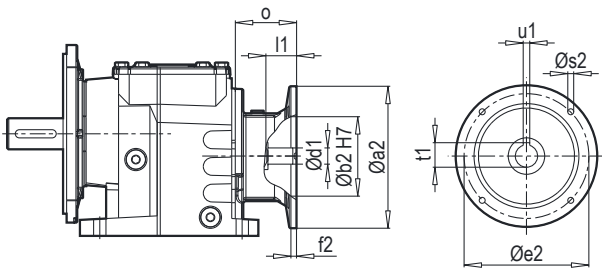

AF 302-303 W

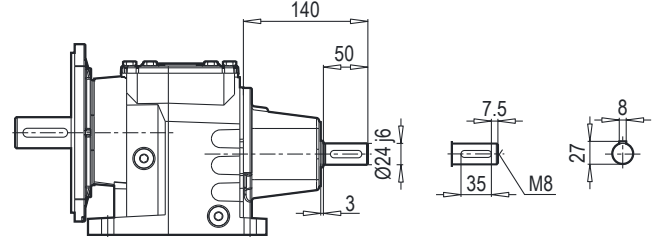

$\sim \text{Kr}$	
A/F 302-303	17

Редуктор	PAM B5	Øa2	Øb2	Øe2	f2	Øs2	Ød1	l1	t1	u1	o
A/F 302 A/F 303	63	140	95	115	4.5	M8	11	25	12.8	4	57
	71	160	110	130	5	M8	14	32	16.3	5	69
	80	200	130	165	5	M10	19	42	21.8	6	90
	90	200	130	165	5	M10	24	52	27.3	8	90
	100	250	180	215	5.5	M12	28	62	31.3	8	105
	112	250	180	215	5.5	M12	28	62	31.3	8	105

$\sim \text{Kr}$	
PAM B5	A/F 302-303
63	15
71	16
80	17
90	17
100	21
112	21

Редуктор	PAM B14	Øa2	Øb2	Øe2	f2	Øs2	Ød1	l1	t1	u1	o
A/F 302 A/F 303	63	90	60	75	2.5	6	11	25	12.8	4	57
	71	105	70	85	2.5	7	14	32	16.3	5	69
	80	120	80	100	3	7	19	42	21.8	6	90
	90	140	95	115	3	9	24	52	27.3	8	90
	100	160	110	130	3.5	9	28	62	31.3	8	105
	112	160	110	130	3.5	9	28	62	31.3	8	105

$\sim \text{Kr}$	
PAM B14	A/F 302-303
63	14
71	15
80	16
90	16
100	17
112	17

A 351

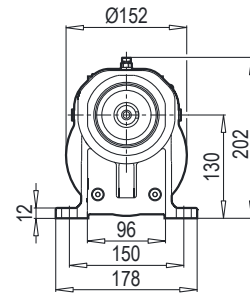
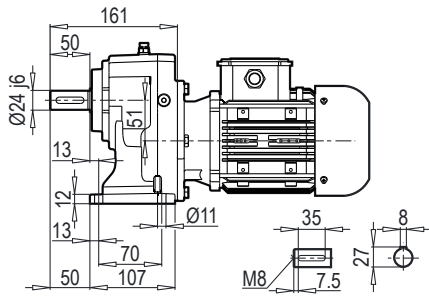

AF-M 351

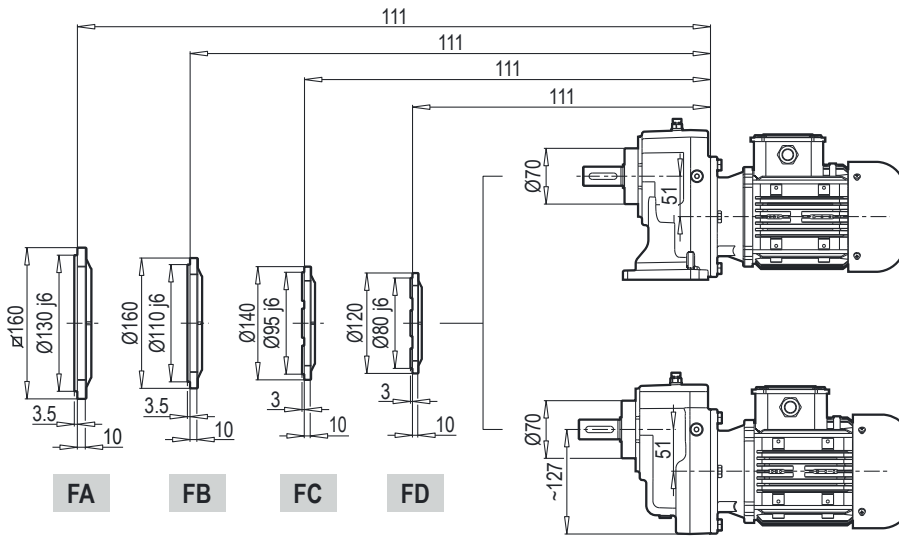
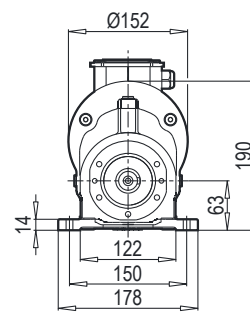
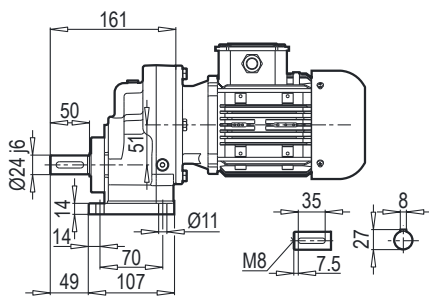

AF 351

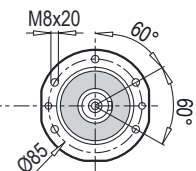

F 351

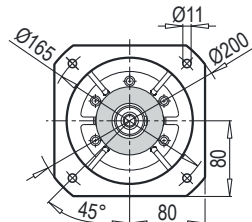
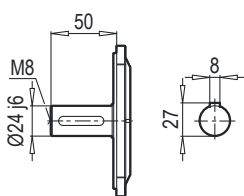

FA

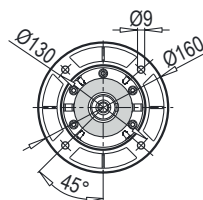

FB

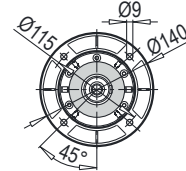

FC

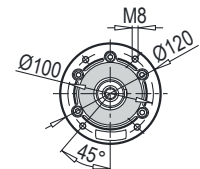

FD

A 351 PAM B5/B14

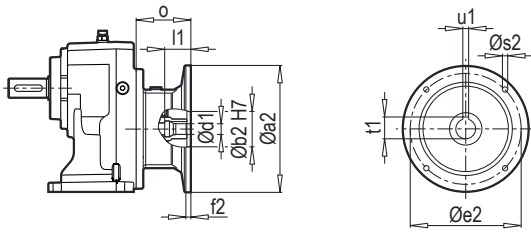

A 351 W

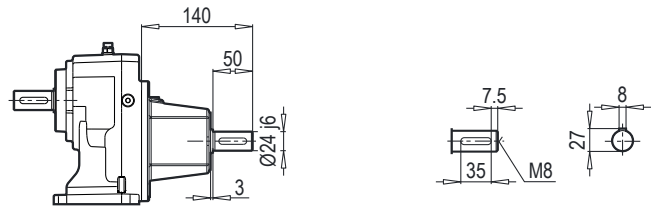

F 351 PAM B5/B14

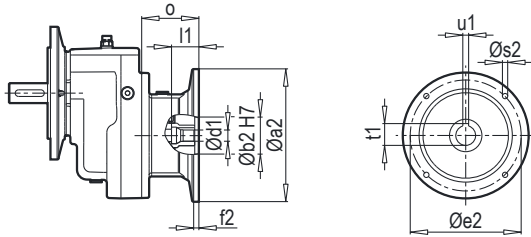

F 351 W

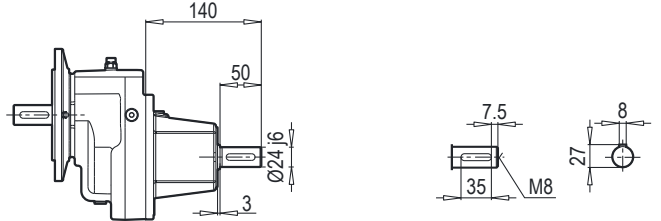

AF 351 PAM B5/B14

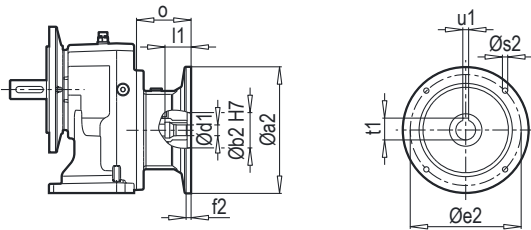

AF 351 W

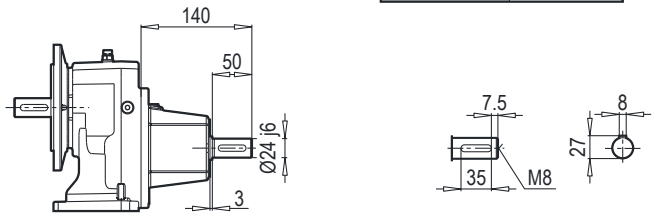

W ~ Kr	
A/F 351	12

AF-M 351 PAM B5/B14

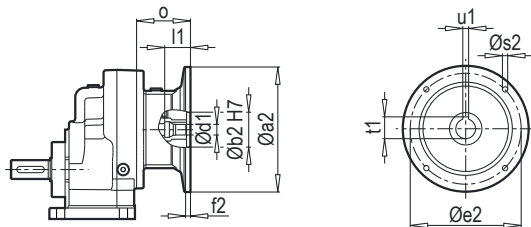

AF-M 351 W

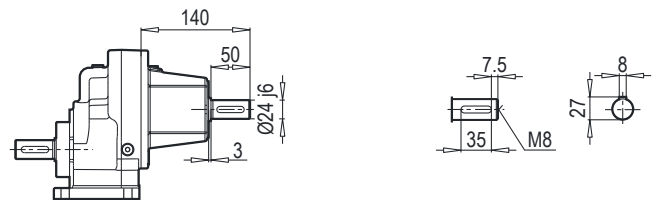

Редуктор	PAM B5	Øa2	Øb2	Øe2	f2	Øs2	Ød1	l1	t1	u1	o
A/F 351	71	160	110	130	5	M8	14	32	16.3	5	69
	80	200	130	165	5	M10	19	42	21.8	6	90
	90	200	130	165	5	M10	24	52	27.3	8	90
	100	250	180	215	5.5	M12	28	62	31.3	8	105
	112	250	180	215	5.5	M12	28	62	31.3	8	105

~ Kr	
PAM B5	A/F 351
71	8
80	8.5
90	8.5
100	13
112	13

Редуктор	PAM B14	Øa2	Øb2	Øe2	f2	Øs2	Ød1	l1	t1	u1	o
A/F 351	71	105	70	85	2.5	7	14	32	16.3	5	69
	80	120	80	100	3	7	19	42	21.8	6	90
	90	140	95	115	3	9	24	52	27.3	8	90
	100	160	110	130	3.5	9	28	62	31.3	8	105
	112	160	110	130	3.5	9	28	62	31.3	8	105

~ Kr	
PAM B14	A/F 351
71	7
80	7.5
90	7.5
100	9.5
112	9.5

A 352-353

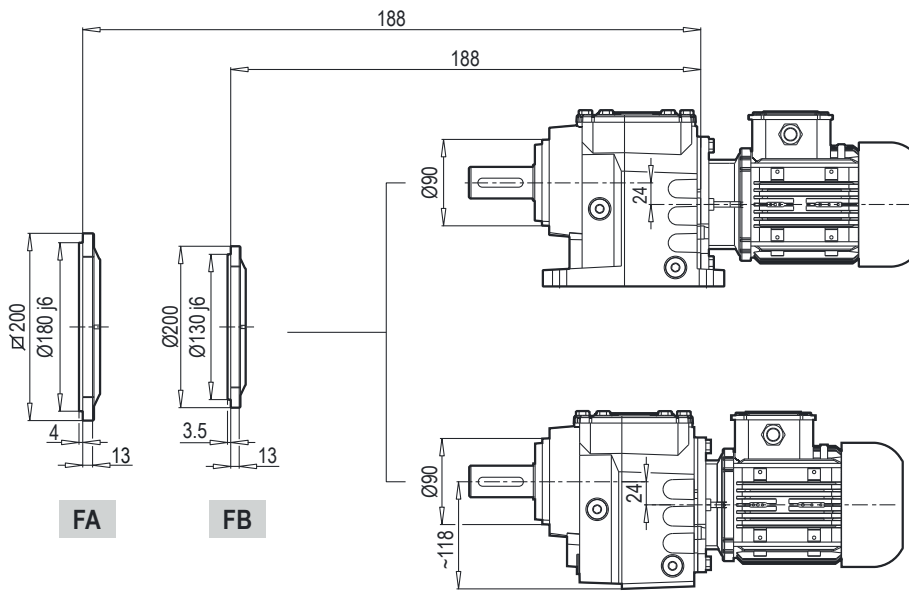
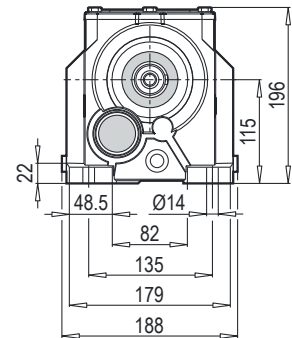
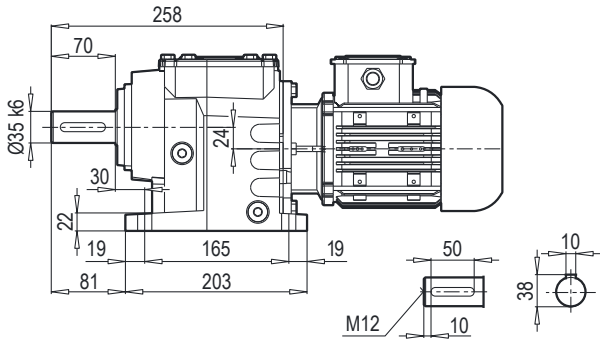

AF 352-353

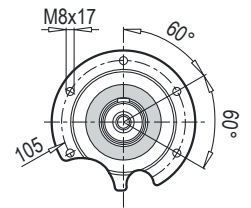

F 352-353

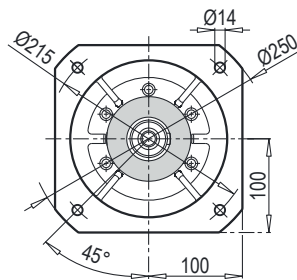
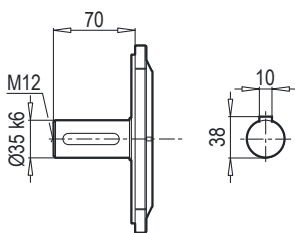

FA

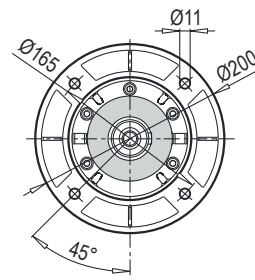

FB

A 352-353 PAM B5/B14

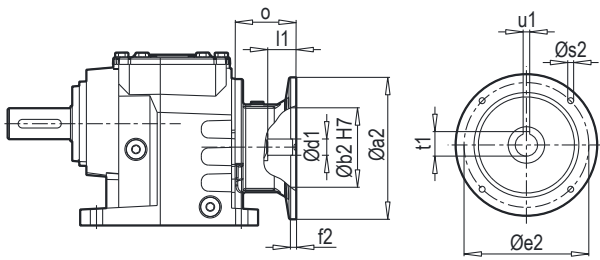

A 352-353 W

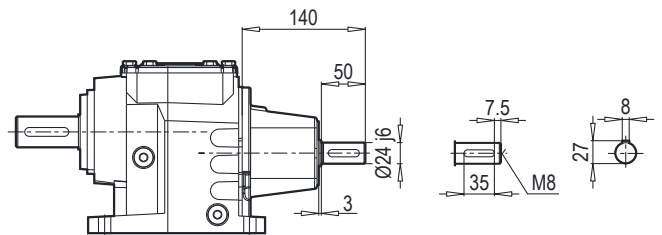

F 352-353 PAM B5/B14

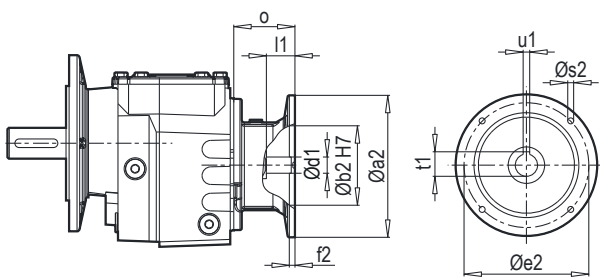

F 352-353 W

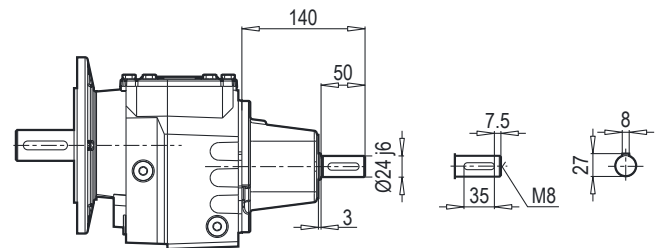

AF 352-353 PAM B5/B14

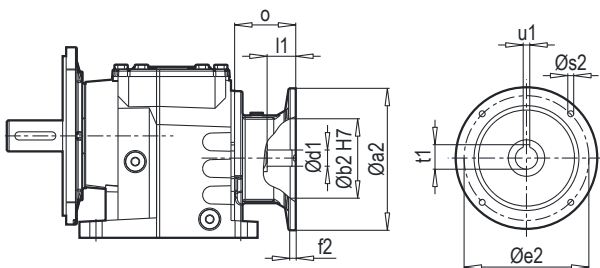

AF 352-353 W

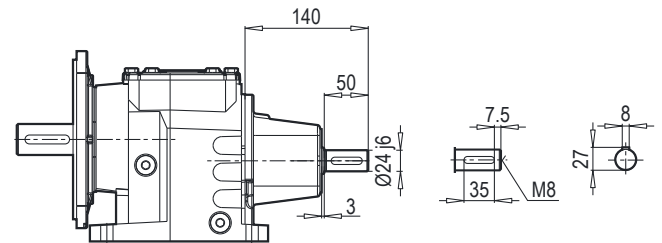

W ~ $\frac{Kr}{\text{mm}}$	
A/F 352-353	22

Редуктор	PAM B5	Øa2	Øb2	Øe2	f2	Øs2	Ød1	l1	t1	u1	o
A/F 352 A/F 353	63	140	95	115	4.5	M8	11	25	12.8	4	57
	71	160	110	130	5	M8	14	32	16.3	5	69
	80	200	130	165	5	M10	19	42	21.8	6	90
	90	200	130	165	5	M10	24	52	27.3	8	90
	100	250	180	215	5.5	M12	28	62	31.3	8	105
	112	250	180	215	5.5	M12	28	62	31.3	8	105

~ $\frac{Kr}{\text{mm}}$	
PAM B5	A/F 352-353
63	20
71	21
80	22
90	22
100	26
112	26

Редуктор	PAM B14	Øa2	Øb2	Øe2	f2	Øs2	Ød1	l1	t1	u1	o
A/F 352 A/F 353	63	90	60	75	2.5	6	11	25	12.8	4	57
	71	105	70	85	2.5	7	14	32	16.3	5	69
	80	120	80	100	3	7	19	42	21.8	6	90
	90	140	95	115	3	9	24	52	27.3	8	90
	100	160	110	130	3.5	9	28	62	31.3	8	105
	112	160	110	130	3.5	9	28	62	31.3	8	105

~ $\frac{Kr}{\text{mm}}$	
PAM B14	A/F 352-353
63	19
71	20
80	21
90	21
100	23
112	23

A 401

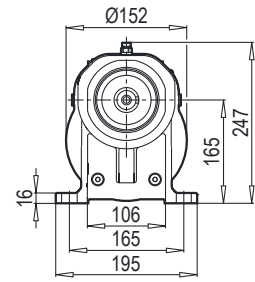
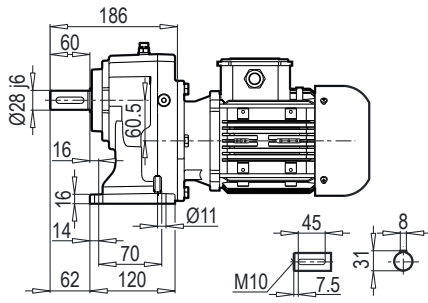

AF-M 401

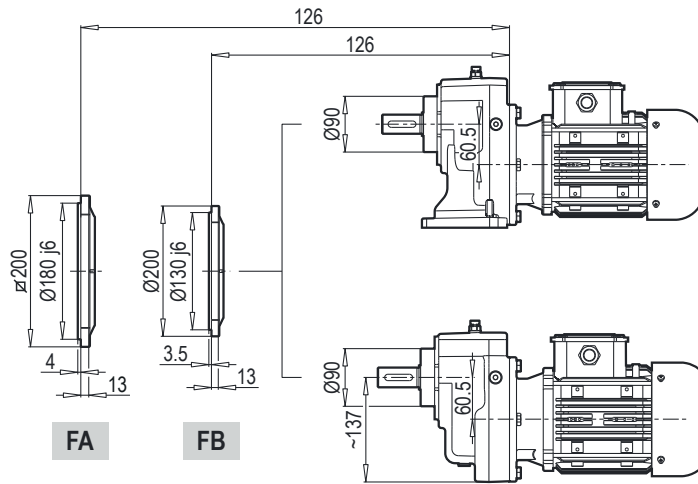
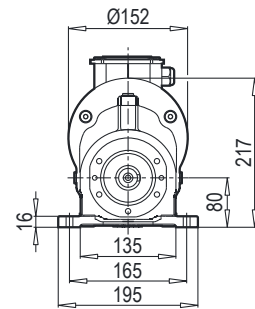
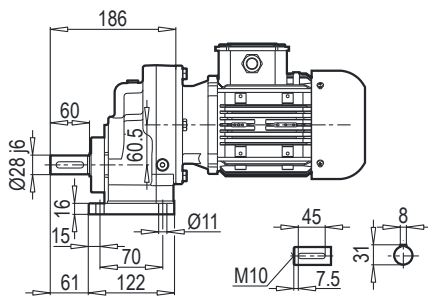

AF 401

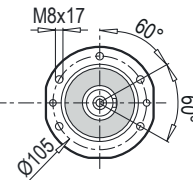

F 401

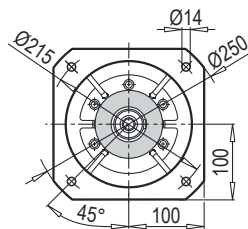
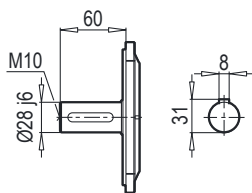

FA

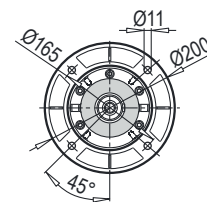

FB

A 401 PAM B5/B14

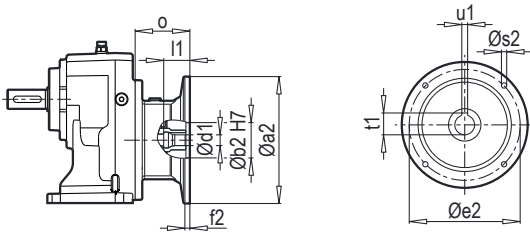

A 401 W

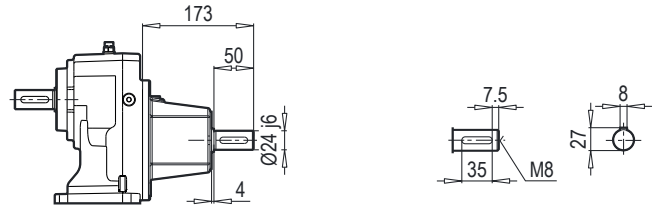

F 401 PAM B5/B14

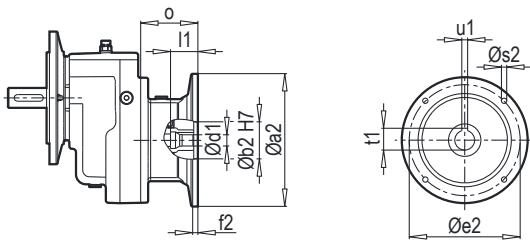

F 401 W

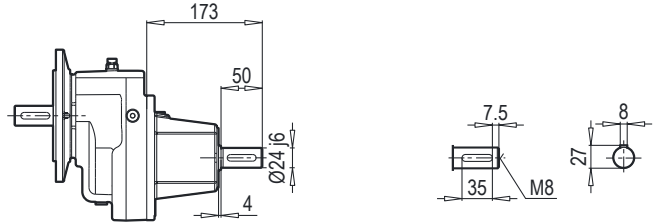

AF 401 PAM B5/B14

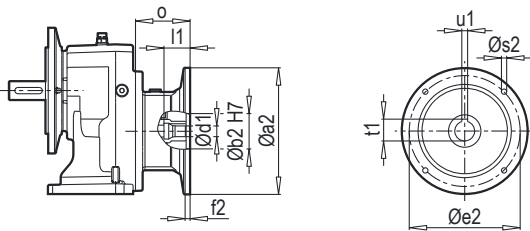

AF 401 W

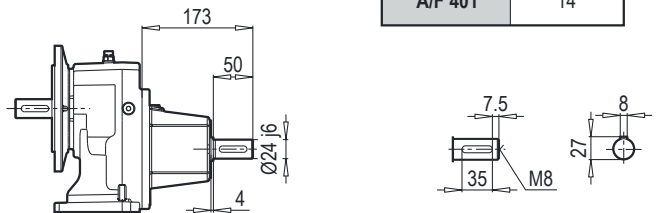

W ~ Kr	
A/F 401	14

AF-M 401 PAM B5/B14

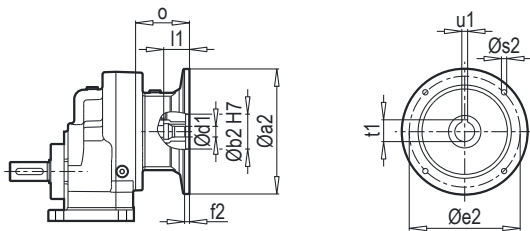

AF-M 401 W

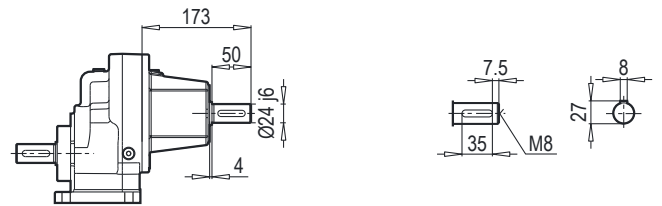

Редуктор	PAM B5	Øa2	Øb2	Øe2	f2	Øs2	Ød1	l1	t1	u1	o
A/F 401	80	200	130	165	5	M10	19	42	21.8	6	90
	90	200	130	165	5	M10	24	52	27.3	8	90
	100	250	180	215	5.5	M12	28	62	31.3	8	105
	112	250	180	215	5.5	M12	28	62	31.3	8	105

~ Kr	
PAM B5	A/F 401
80	11
90	11
100	15.5
112	15.5

Редуктор	PAM B14	Øa2	Øb2	Øe2	f2	Øs2	Ød1	l1	t1	u1	o
A/F 401	80	120	80	100	3	7	19	42	21.8	6	90
	90	140	95	115	3	9	24	52	27.3	8	90
	100	160	110	130	3.5	9	28	62	31.3	8	105
	112	160	110	130	3.5	9	28	62	31.3	8	105

~ Kr	
PAM B14	A/F 401
80	10
90	10
100	12
112	12

A 402-403

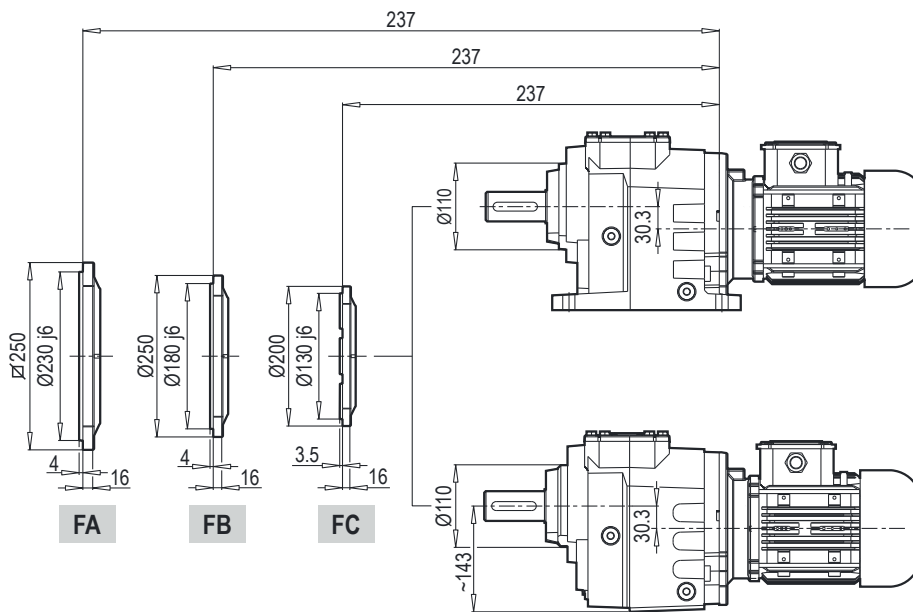
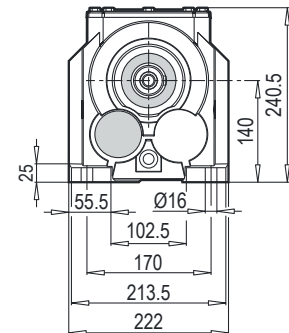
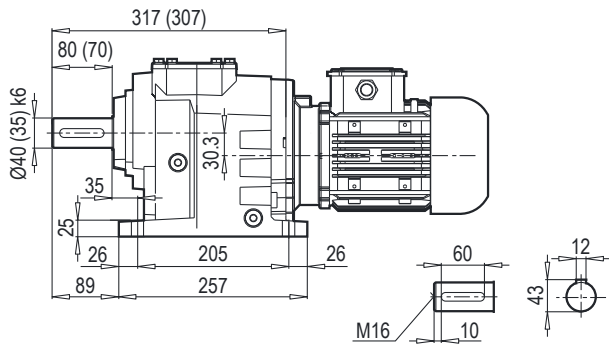

AF 402-403

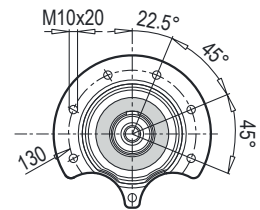

F 402-403

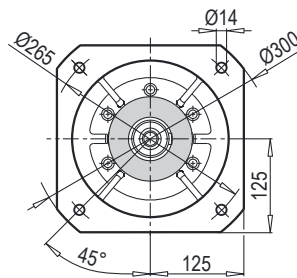
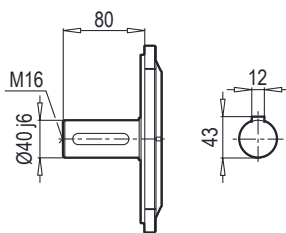

FA

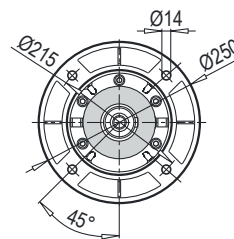

FB

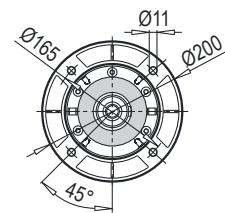

FC

A 402-403 PAM B5/B14

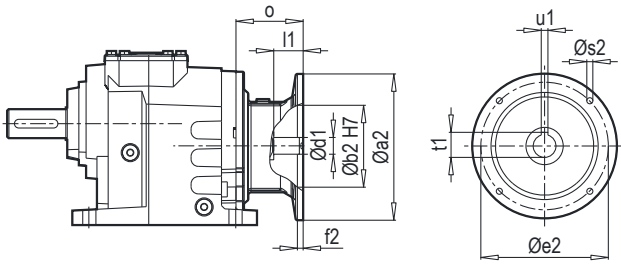

A 402-403 W

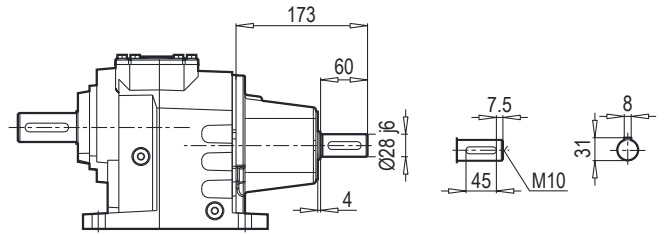

F 402-403 PAM B5/B14

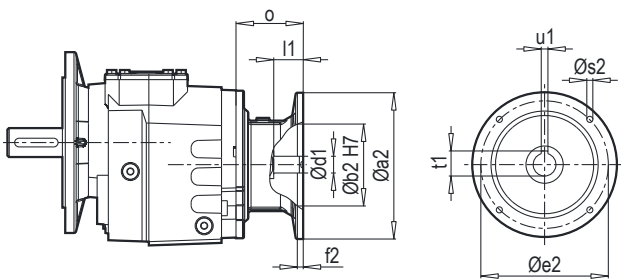

F 402-403 W

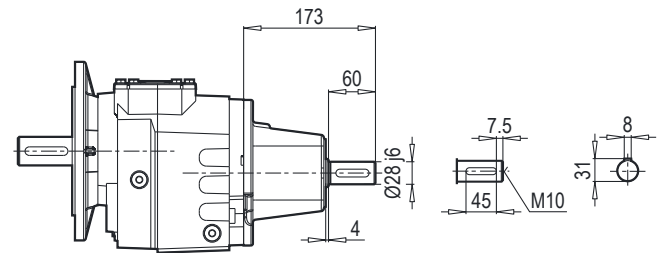

AF 402-403 PAM B5/B14

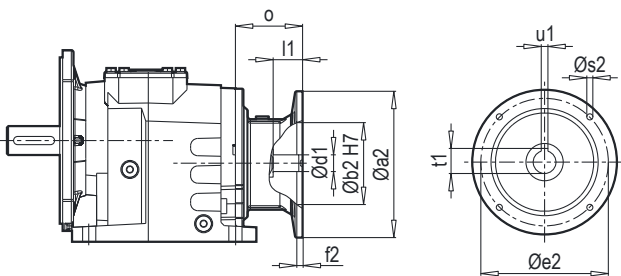

AF 402-403 W

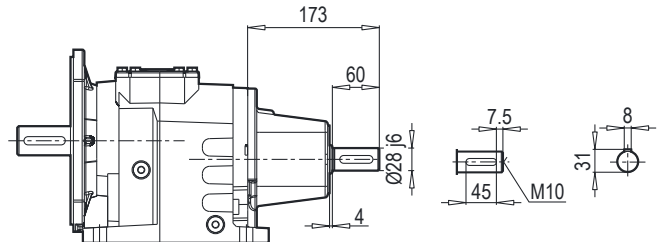

W ~ Kr	
A/F 402-403	37

Редуктор	PAM B5	Øa2	Øb2	Øe2	f2	Øs2	Ød1	l1	t1	u1	o
A/F 402 A/F 403	71	160	110	130	5	M8	14	32	16.3	5	49
	80	200	130	165	5	M10	19	42	21.8	6	70
	90	200	130	165	5	M10	24	52	27.3	8	70
	100	250	180	215	5.5	M12	28	62	31.3	8	85
	112	250	180	215	5.5	M12	28	62	31.3	8	85
	132	300	230	265	5.5	M12	38	82	41.3	10	110

~ Kr	
PAM B5	A/F 402-403
71	32
80	35
90	35
100	37
112	37
132	41

Редуктор	PAM B14	Øa2	Øb2	Øe2	f2	Øs2	Ød1	l1	t1	u1	o
A/F 402 A/F 403	71	105	70	85	2.5	7	14	32	16.3	5	49
	80	120	80	100	3	7	19	42	21.8	6	70
	90	140	95	115	3	9	24	52	27.3	8	70
	100	160	110	130	3.5	9	28	62	31.3	8	85
	112	160	110	130	3.5	9	28	62	31.3	8	85
	132	200	130	165	3.5	11	38	82	41.3	10	110

~ Kr	
PAM B14	A/F 402-403
71	30
80	31
90	31
100	32
112	32
132	38

A 501

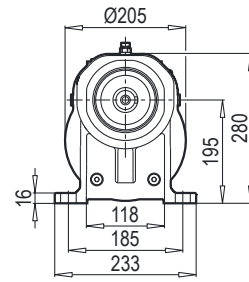
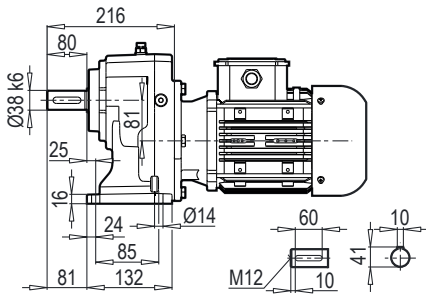

AF-M 501

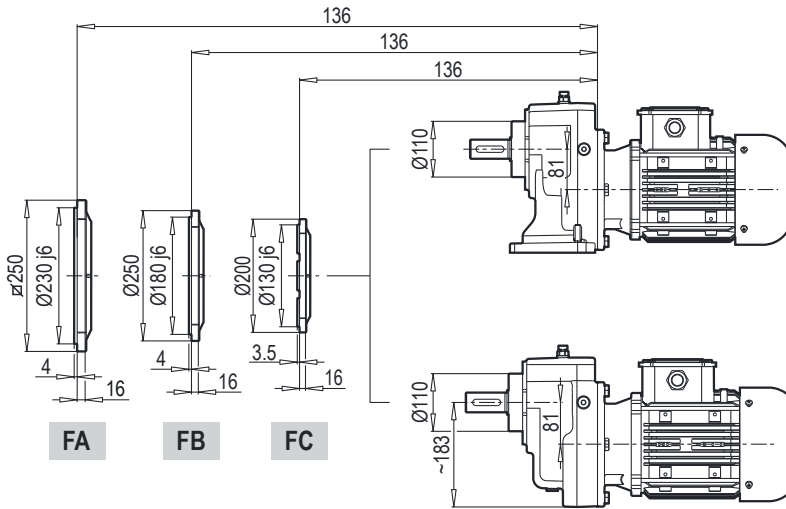
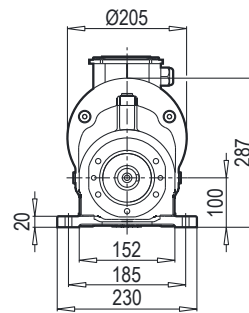
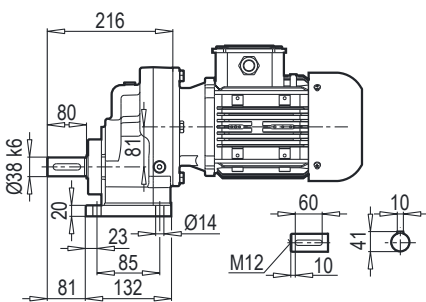

AF 501

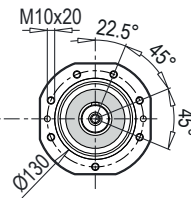

F 501

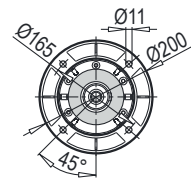
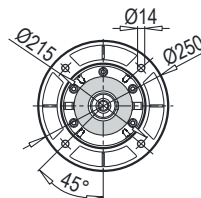
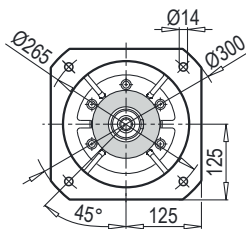
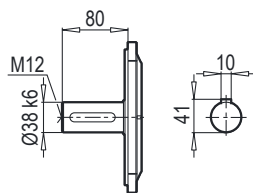

FA

FB

FC

A 501 PAM B5/B14

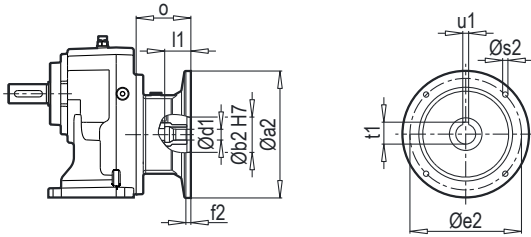

A 501 W

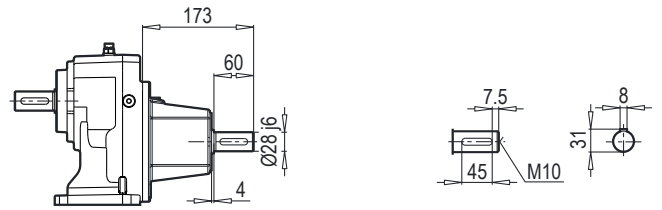

F 501 PAM B5/B14

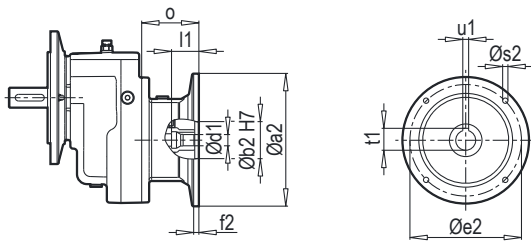

F 501 W

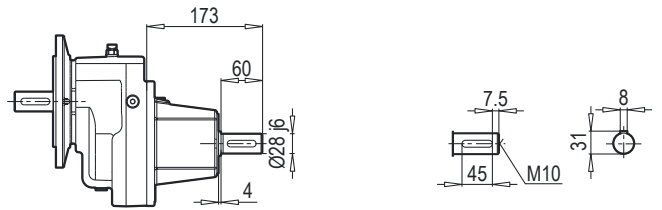

AF 501 PAM B5/B14

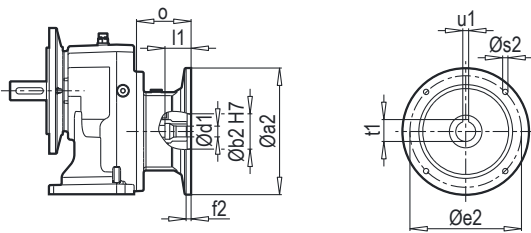

AF 501 W

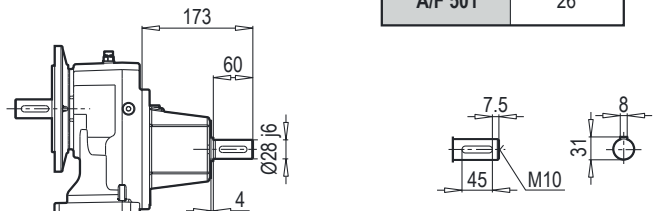

W ~ Kr	
A/F 501	26

AF-M 501 PAM B5/B14

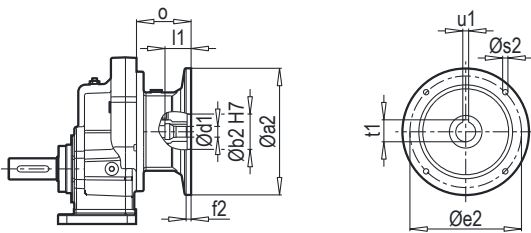

AF-M 501 W

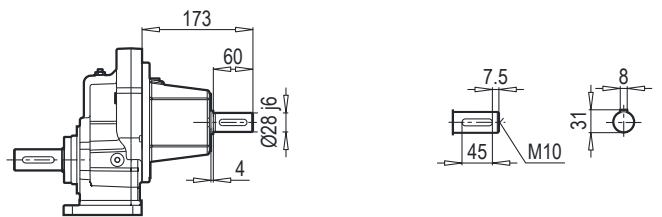

Редуктор	PAM B5	Øa2	Øb2	Øe2	f2	Øs2	Ød1	l1	t1	u1	o
A/F 501	80	200	130	165	5	M10	19	42	21.8	6	70
	90	200	130	165	5	M10	24	52	27.3	8	70
	100	250	180	215	5.5	M12	28	62	31.3	8	85
	112	250	180	215	5.5	M12	28	62	31.3	8	85
	132	300	230	265	5.5	M12	38	82	41.3	10	110

~ Kr	
PAM B5	A/F 501
80	22
90	22
100	25
112	25
132	27

	PAM B14	Øa2	Øb2	Øe2	f2	Øs2	Ød1	l1	t1	u1	o
A/F 501	80	120	80	100	3	7	19	42	21.8	6	70
	90	140	95	115	3	9	24	52	27.3	8	70
	100	160	110	130	3.5	9	28	62	31.3	8	85
	112	160	110	130	3.5	9	28	62	31.3	8	85
	132	200	130	165	3.5	11	38	82	41.3	10	110

~ Kr	
PAM B14	A/F 501
80	18.5
90	18.5
100	21
112	21
132	24

A 502-503

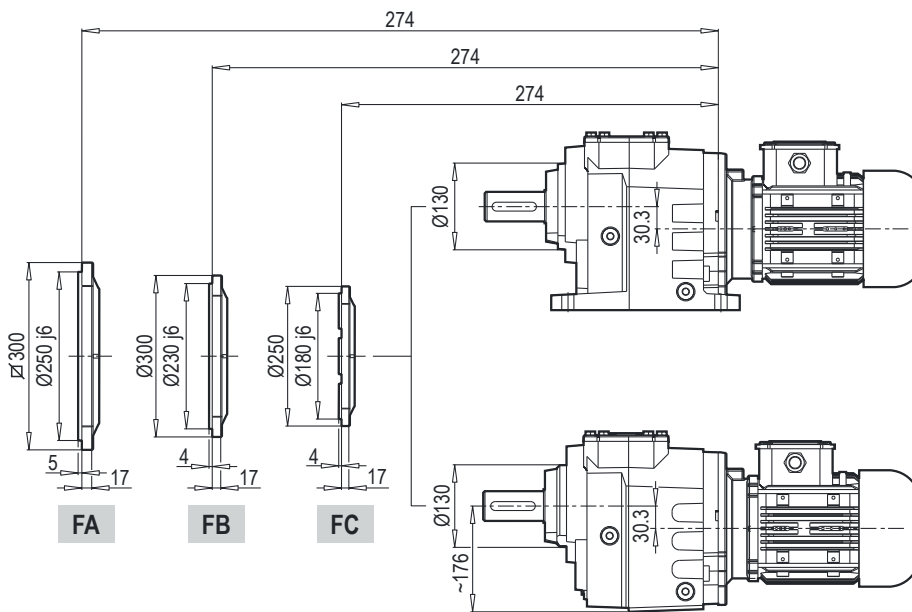
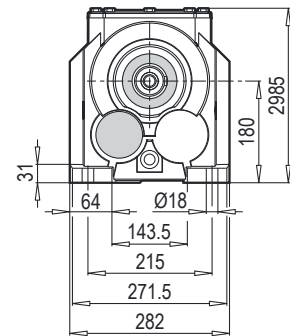
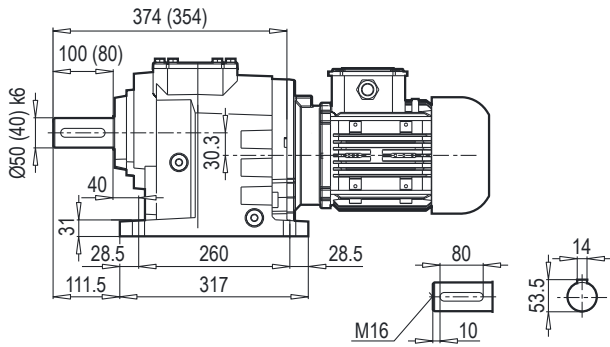

AF 502-503

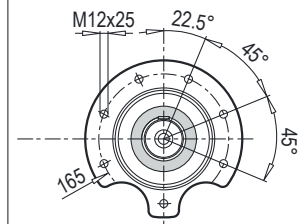

F 502-503

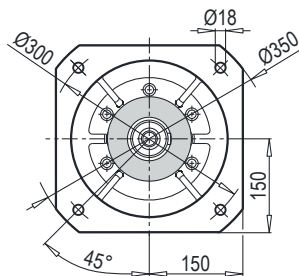
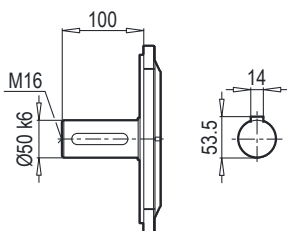

FA

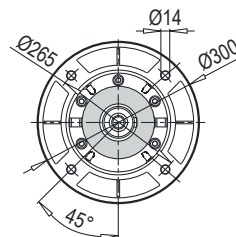

FB

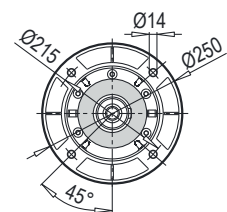

FC

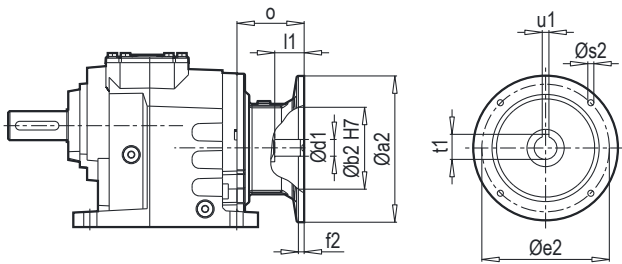
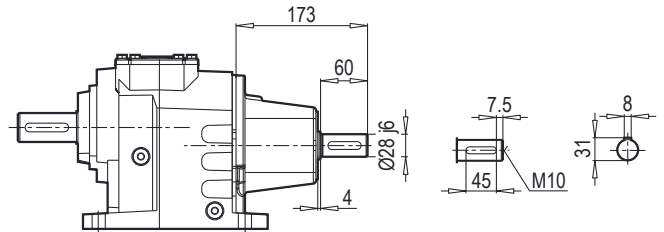
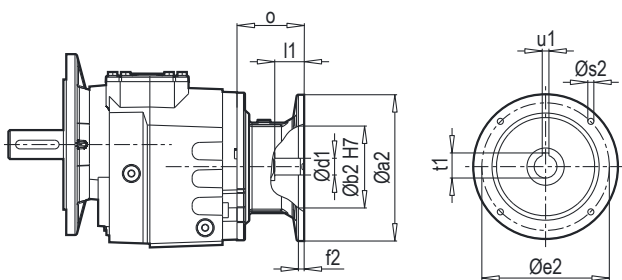
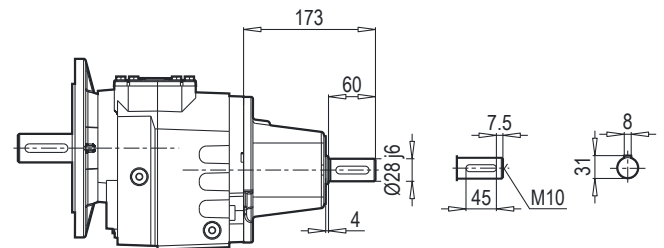
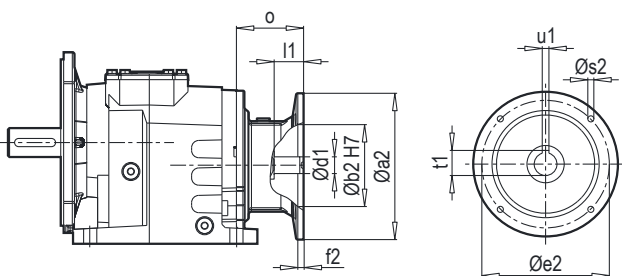
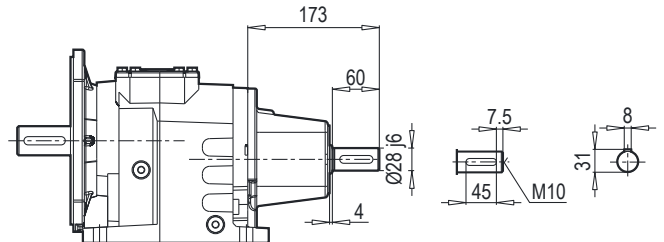
A 502-503 PAM B5/B14

A 502-503 W

F 502-503 PAM B5/B14

F 502-503 W

AF 502-503 PAM B5/B14

AF 502-503 W

W ~ $\frac{Kr}{\text{mm}}$	
A/F 502-503	54

Редуктор	PAM B5	Øa2	Øb2	Øe2	f2	Øs2	Ød1	l1	t1	u1	o
A/F 502 A/F 503	80	200	130	165	5	M10	19	42	21.8	6	70
	90	200	130	165	5	M10	24	52	27.3	8	70
	100	250	180	215	5.5	M12	28	62	31.3	8	85
	112	250	180	215	5.5	M12	28	62	31.3	8	85
	132	300	230	265	5.5	M12	38	82	41.3	10	110
	160	350	250	300	7	M16	42	112	45.3	12	158

~ $\frac{Kr}{\text{mm}}$	
PAM B5	A/F 502-503
80	52
90	52
100	54
112	54
132	58
160	65

Редуктор	PAM B14	Øa2	Øb2	Øe2	f2	Øs2	Ød1	l1	t1	u1	o
A/F 502 A/F 503	80	120	80	100	3	7	19	42	21.8	6	70
	90	140	95	115	3	9	24	52	27.3	8	70
	100	160	110	130	3.5	9	28	62	31.3	8	85
	112	160	110	130	3.5	9	28	62	31.3	8	85
	132	200	130	165	3.5	11	38	82	41.3	10	110

~ $\frac{Kr}{\text{mm}}$	
PAM B14	A/F 502-503
80	48
90	48
100	50
112	50
132	55

A 601

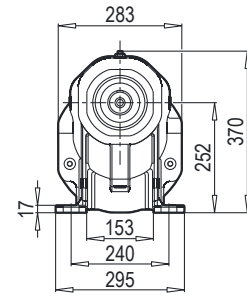
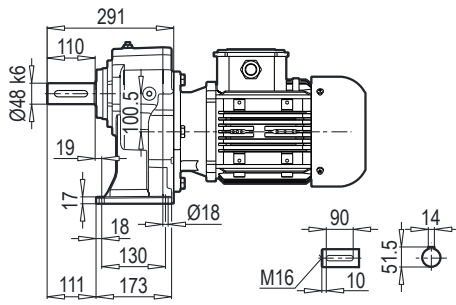

AF-M 601

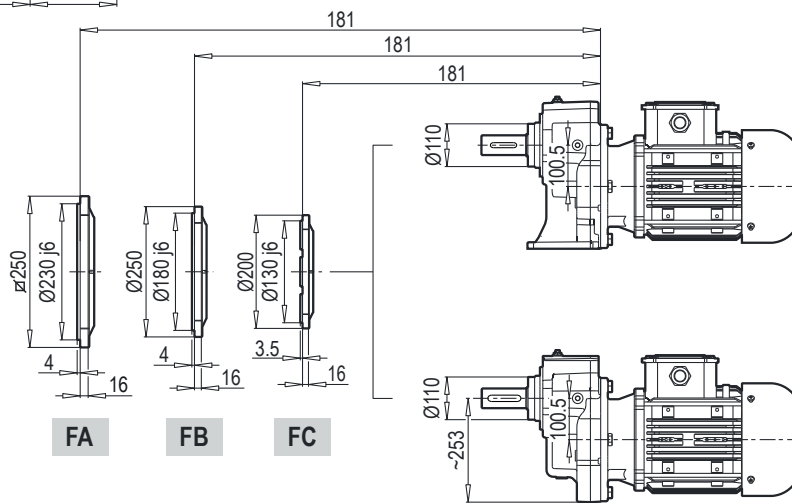
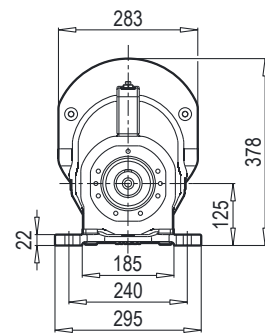
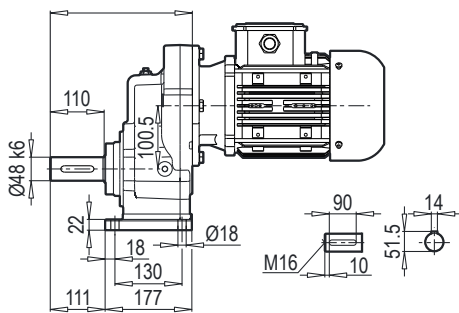

AF 601

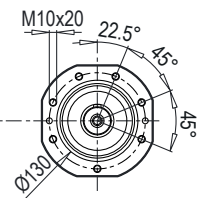

F 601

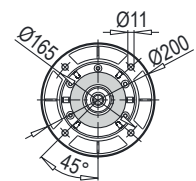
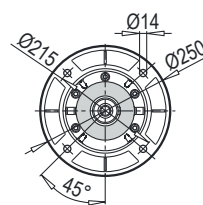
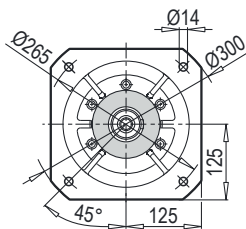
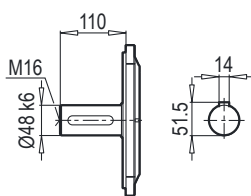

FA

FB

FC

A 601 PAM B5/B14

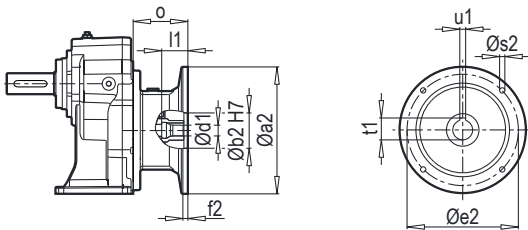

A 601 W

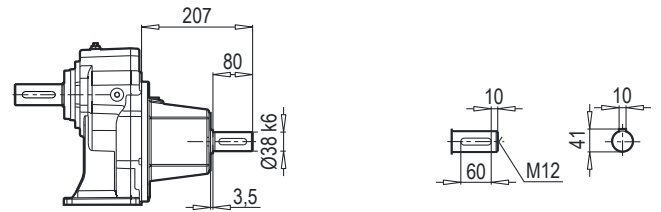

F 601 PAM B5/B14

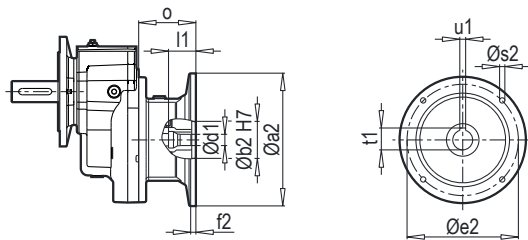

F 601 W

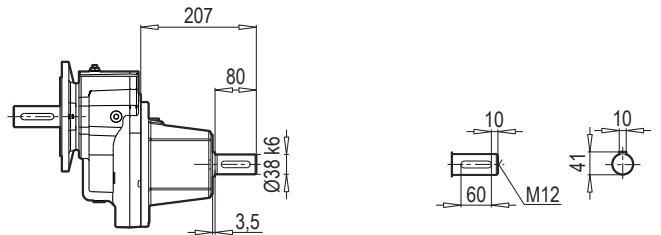

AF 601 PAM B5/B14

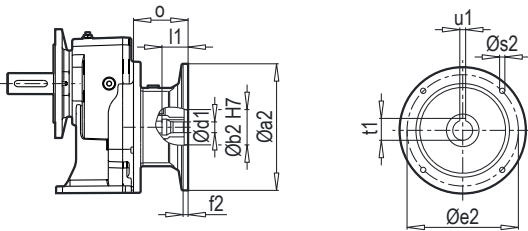

AF 601 W

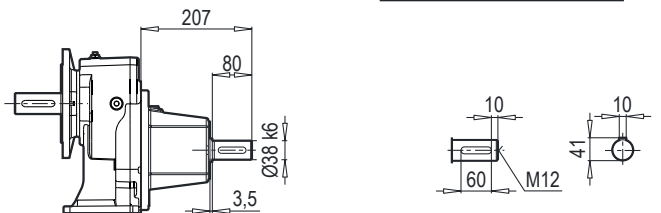

W ~ Kr	
A/F 601	45

AF-M 601 PAM B5/B14

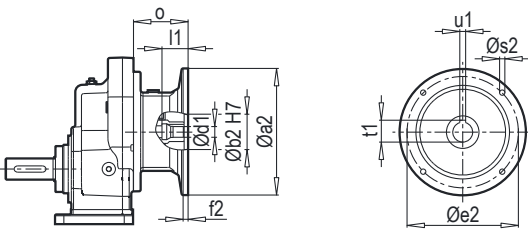

AF-M 601 W

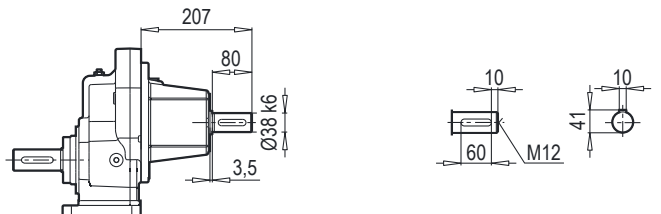

Редуктор	PAM B5	Øa2	Øb2	Øe2	f2	Øs2	Ød1	l1	t1	u1	o
A/F 601	100	250	180	215	5.5	M12	28	62	31.3	8	76
	112	250	180	215	5.5	M12	28	62	31.3	8	76
	132	300	230	265	5.5	M12	38	82	41.3	10	101
	160	350	250	300	7	M16	42	112	45.3	12	148
	180	350	250	300	7	M16	48	112	51.8	14	148

~ Kr	
PAM B5	A/F 601
100	37
112	37
132	40
160	47
180	47

Редуктор	PAM B14	Øa2	Øb2	Øe2	f2	Øs2	Ød1	l1	t1	u1	o
A/F 601	100	160	110	130	3.5	9	28	62	31.3	8	76
	112	160	110	130	3.5	9	28	62	31.3	8	76
	132	200	130	165	3.5	11	38	82	41.3	10	101

~ Kr	
PAM B14	A/F 601
100	34.5
112	34.5
132	38

A 602 - 603

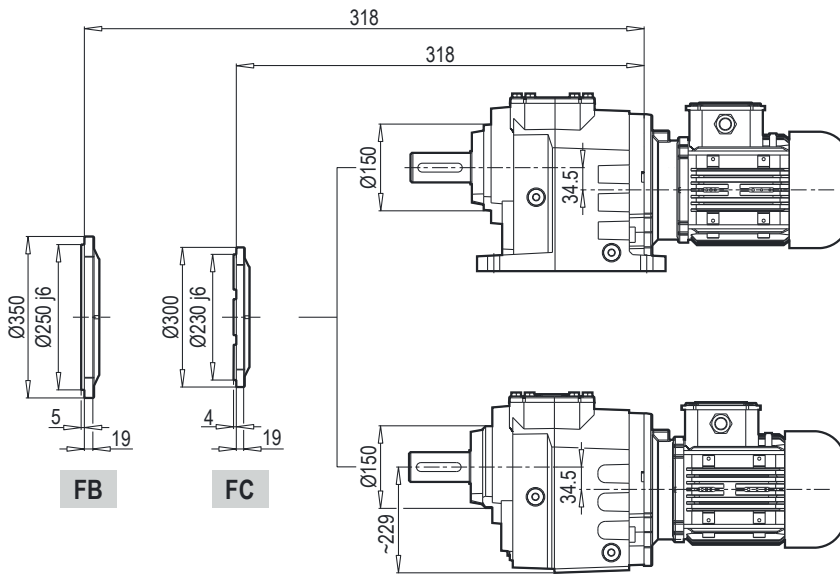
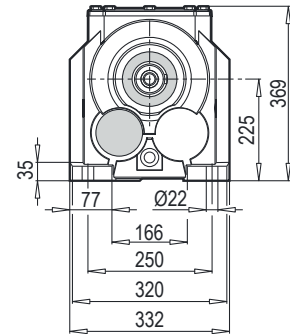
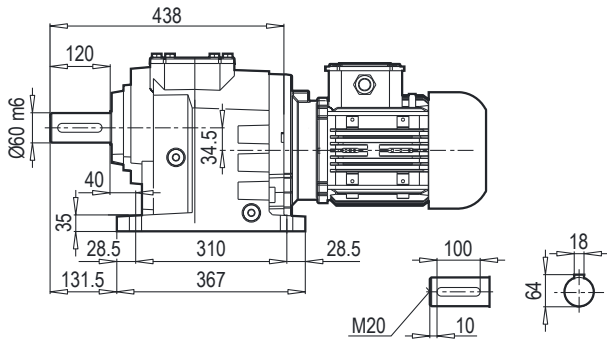

AF 602 - 603

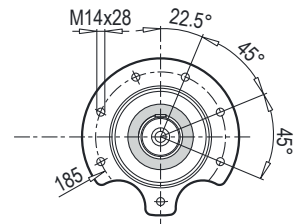

F 602 - 603

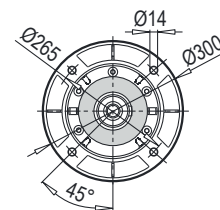
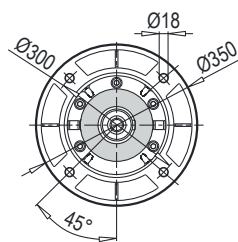
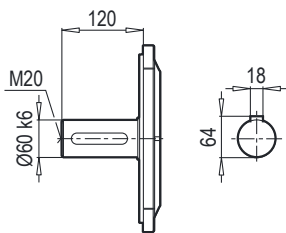

FB

FC

A 602-603 PAM B5/B14

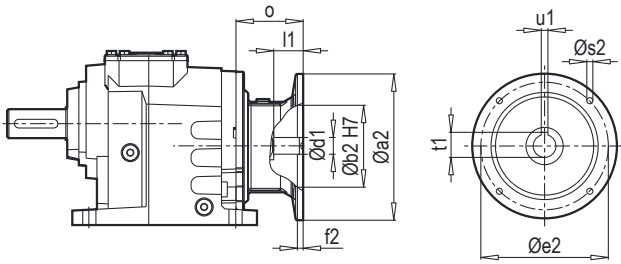

A 602-603 W

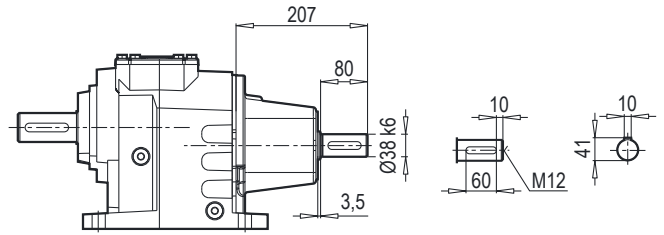

F 602-603 PAM B5/B14

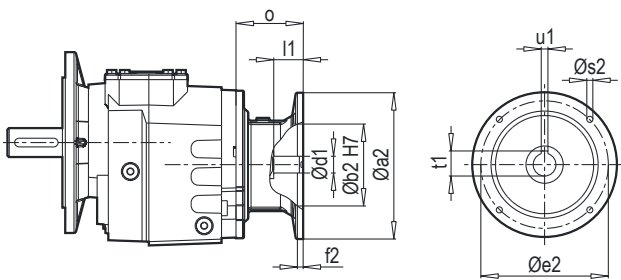

F 602-603 W

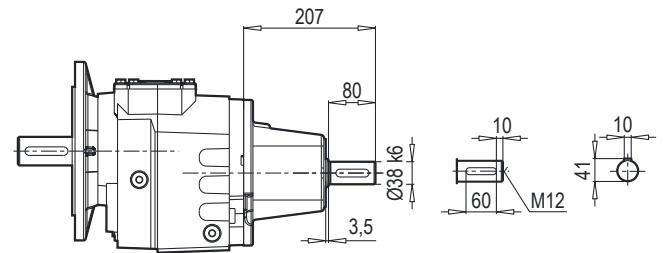

AF 602-603 PAM B5/B14

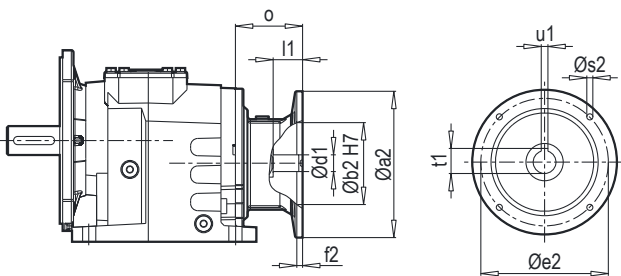

AF 602-603 W

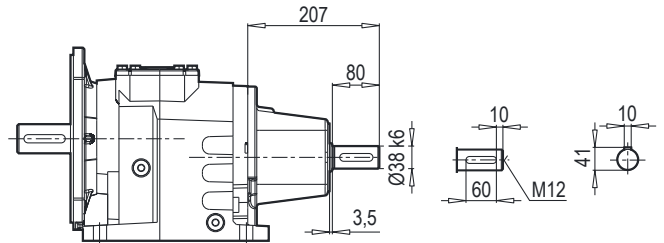

W ~ $\frac{Kr}{\text{mm}}$	
A/F 602-603	90

Редуктор	PAM B5	Øa2	Øb2	Øe2	f2	Øs2	Ød1	l1	t1	u1	o
A/F 602 A/F 603	90	200	130	165	5	M10	24	52	27.3	8	61
	100	250	180	215	5.5	M12	28	62	31.3	8	76
	112	250	180	215	5.5	M12	28	62	31.3	8	76
	132	300	230	265	5.5	M12	38	82	41.3	10	101
	160	350	250	300	7	M16	42	112	45.3	12	148
	180	350	250	300	7	M16	48	112	51.8	14	148

~ $\frac{Kr}{\text{mm}}$	
PAM B5	A/F 602-603
90	81
100	85
112	85
132	88
160	94
180	94

Редуктор	PAM B14	Øa2	Øb2	Øe2	f2	Øs2	Ød1	l1	t1	u1	o
A/F 602 A/F 603	90	140	95	115	3	9	24	52	27.3	8	61
	100	160	110	130	3.5	9	28	62	31.3	8	76
	112	160	110	130	3.5	9	28	62	31.3	8	76
	132	200	130	165	3.5	11	38	82	41.3	10	101

~ $\frac{Kr}{\text{mm}}$	
PAM B14	A/F 602-603
90	78
100	80
112	80
132	86

A 701

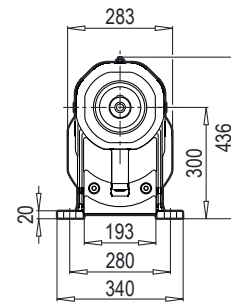
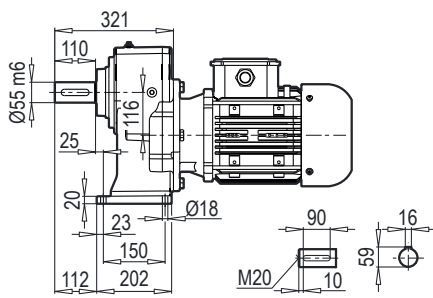

AF-M 701

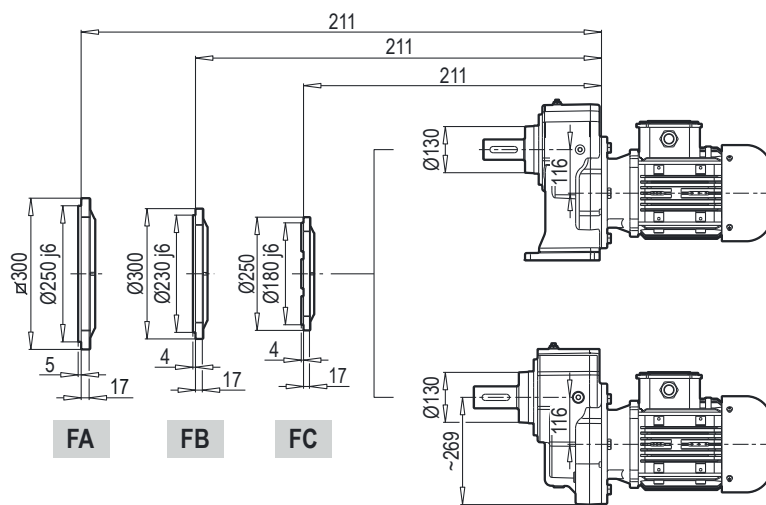
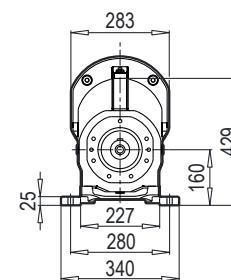
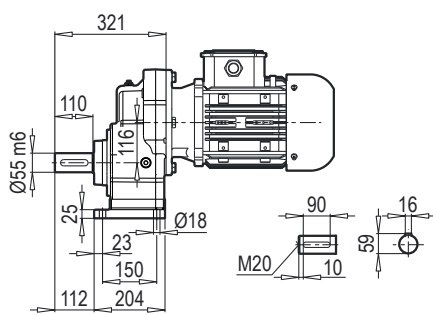

AF 701

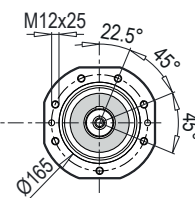

F 701

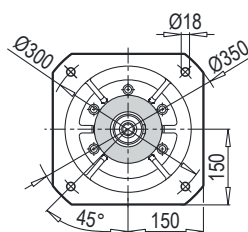
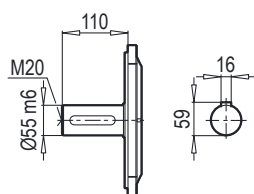

FA

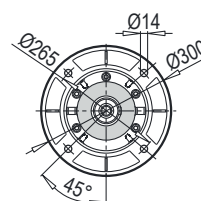

FB

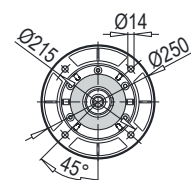

FC

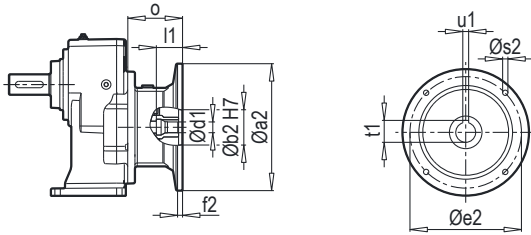
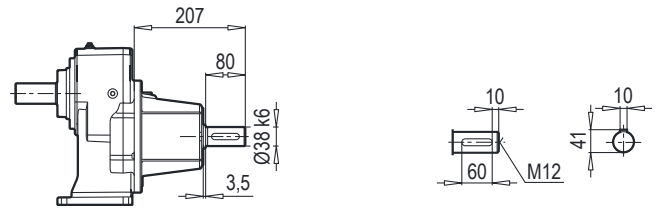
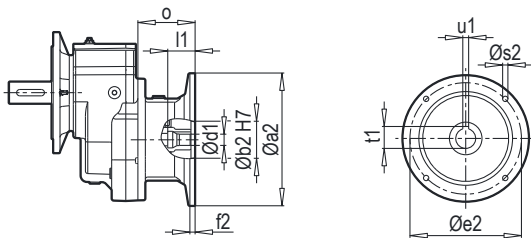
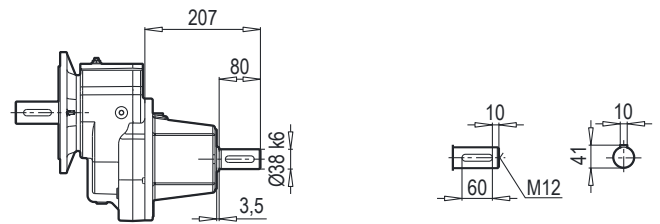
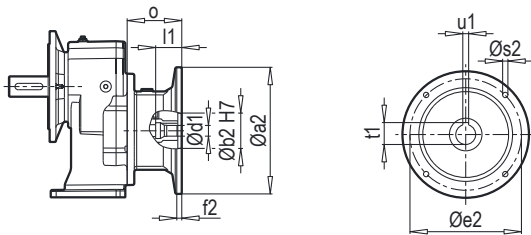
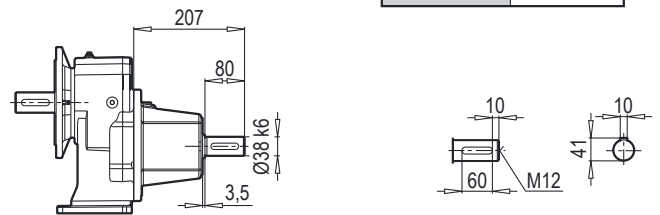
A 701 PAM B5/B14

A 701 W

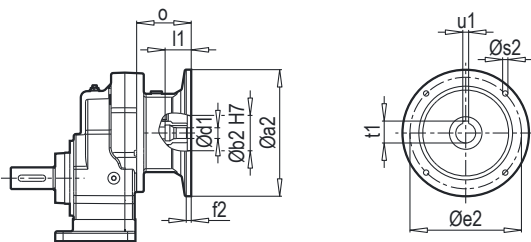
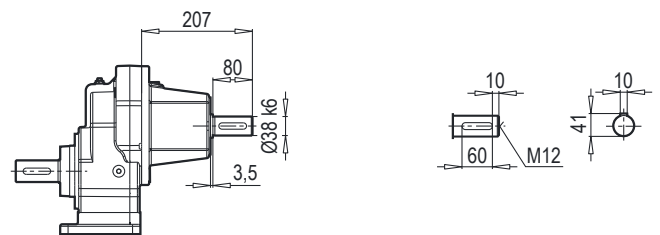
F 701 PAM B5/B14

F 701 W

AF 701 PAM B5/B14

AF 701 W

W ~ Kr	
A/F 701	49

AF-M 701 PAM B5/B14

AF-M 701 W

Редуктор	PAM B5	Øa2	Øb2	Øe2	f2	Øs2	Ød1	l1	t1	u1	o
A/F 701	132	300	230	265	5.5	M12	38	82	41.3	10	101
	160	350	250	300	7	M16	42	112	45.3	12	148
	180	350	250	300	7	M16	48	112	51.8	14	148
	200	400	300	350	7	M16	55	112	59.3	16	185

~ Kr	
PAM B5	A/F 701
132	43
160	50
180	50
200	65

Редуктор	PAM B14	Øa2	Øb2	Øe2	f2	Øs2	Ød1	l1	t1	u1	o
A/F 701	132	200	130	165	3.5	11	38	82	41.3	10	101

~ Kr	
PAM B14	A/F 701
132	41

A 702 - 703

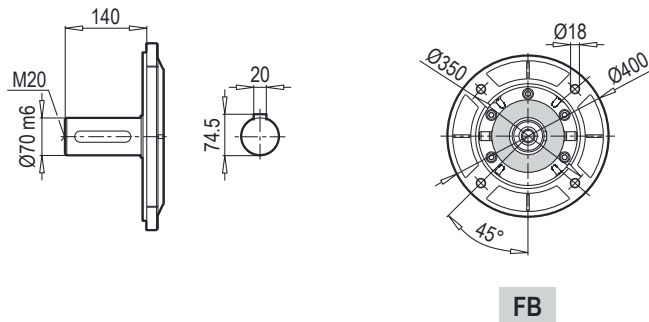
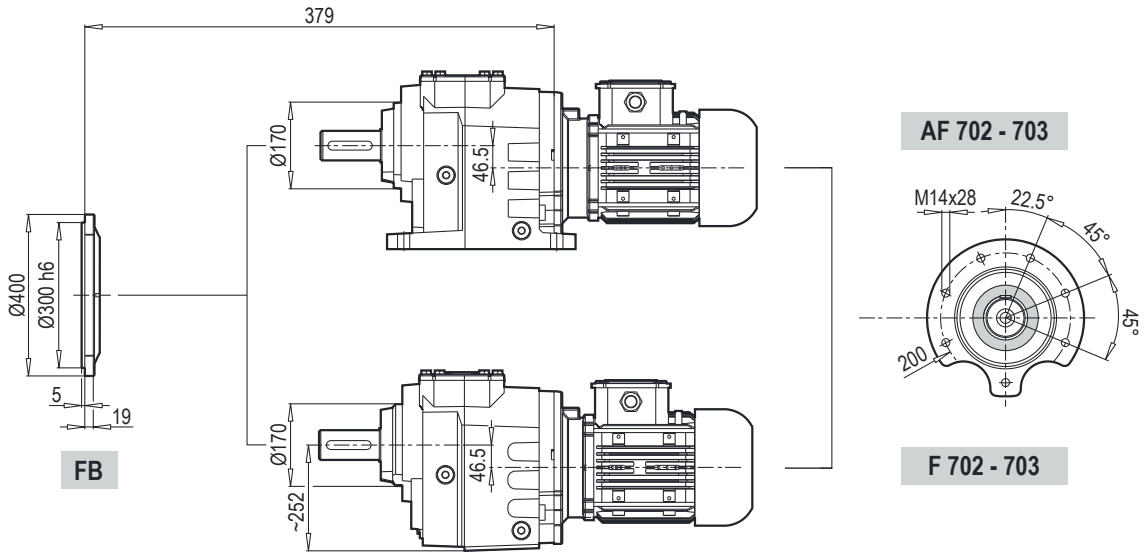
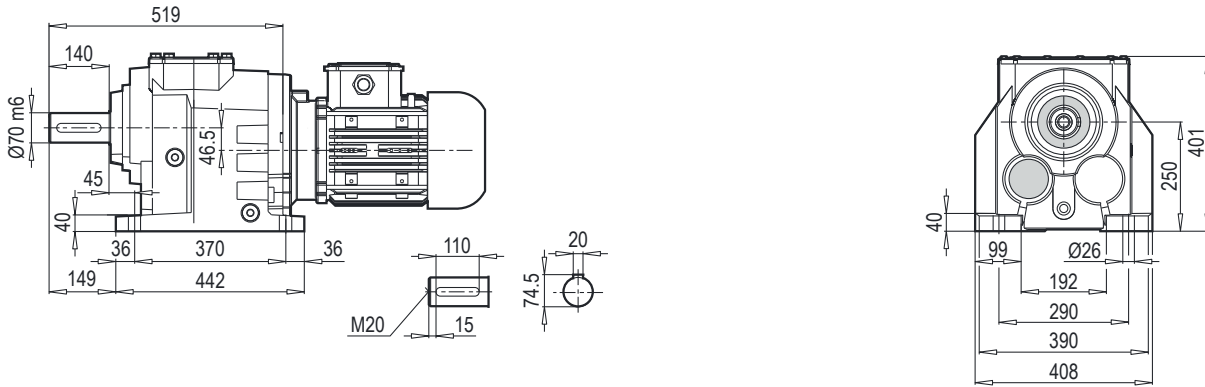

A 702-703 PAM B5/B14

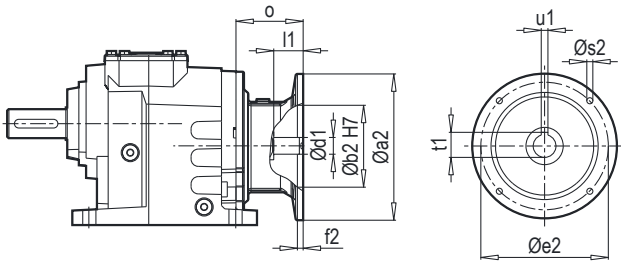

A 702-703 W

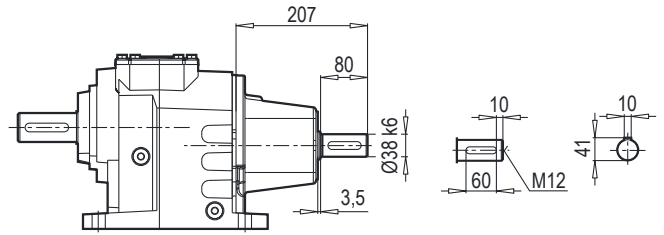

F 702-703 PAM B5/B14

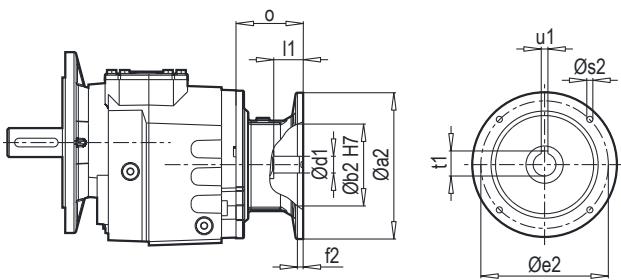

F 702-703 W

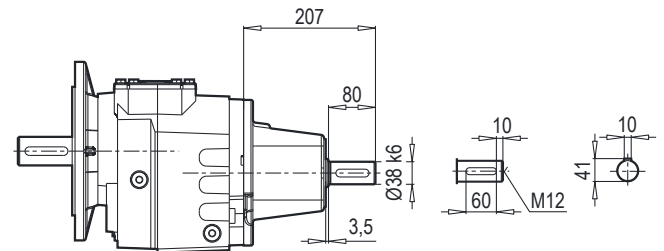

AF 702-703 PAM B5/B14

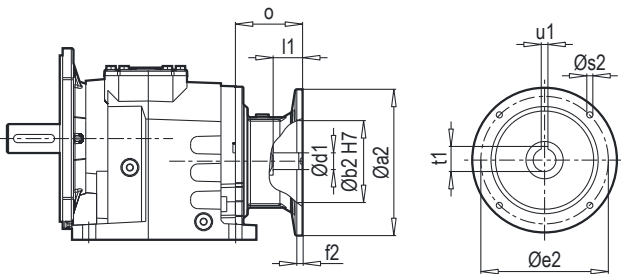

AF 702-703 W

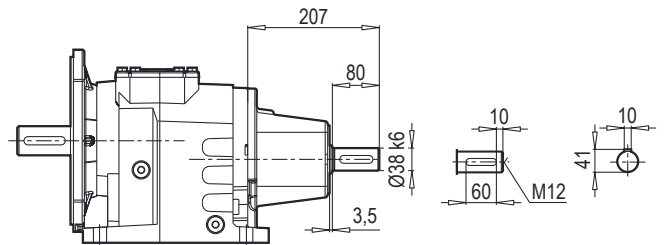

W ~ Kr	
A/F 702-703	119

Редуктор	PAM B5	Øa2	Øb2	Øe2	f2	Øs2	Ød1	l1	t1	u1	o
A/F 702 A/F 703	100	250	180	215	5.5	M12	28	62	31.3	8	76
	112	250	180	215	5.5	M12	28	62	31.3	8	76
	132	300	230	265	5.5	M12	38	82	41.3	10	101
	160	350	250	300	7	M16	42	112	45.3	12	148
	180	350	250	300	7	M16	48	112	51.8	14	148
	200	400	300	350	7	M16	55	112	59.3	16	185

~ Kr	
PAM B5	A/F 702-703
100	114
112	114
132	117
160	123
180	123
200	139

Редуктор	PAM B14	Øa2	Øb2	Øe2	f2	Øs2	Ød1	l1	t1	u1	o
A/F 702 A/F 703	100	160	110	130	3.5	9	28	62	31.3	8	76
	112	160	110	130	3.5	9	28	62	31.3	8	76
	132	200	130	165	3.5	11	38	82	41.3	10	101

~ Kr	
PAM B14	A/F 702-703
100	109
112	109
132	115

A 902 - 903

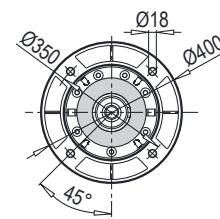
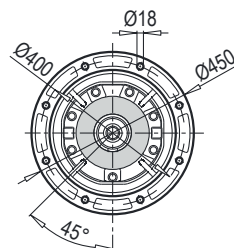
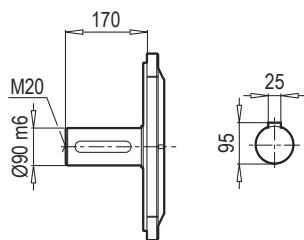
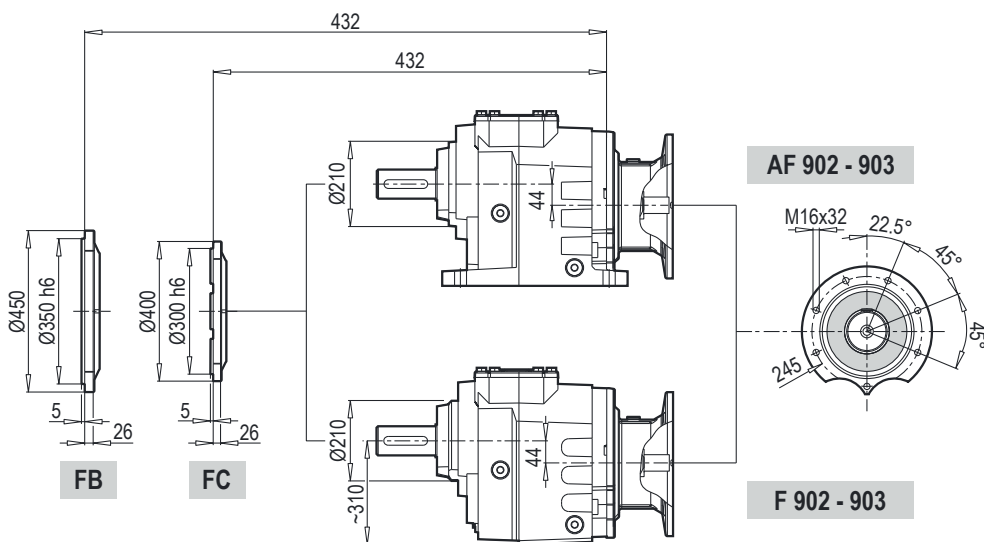
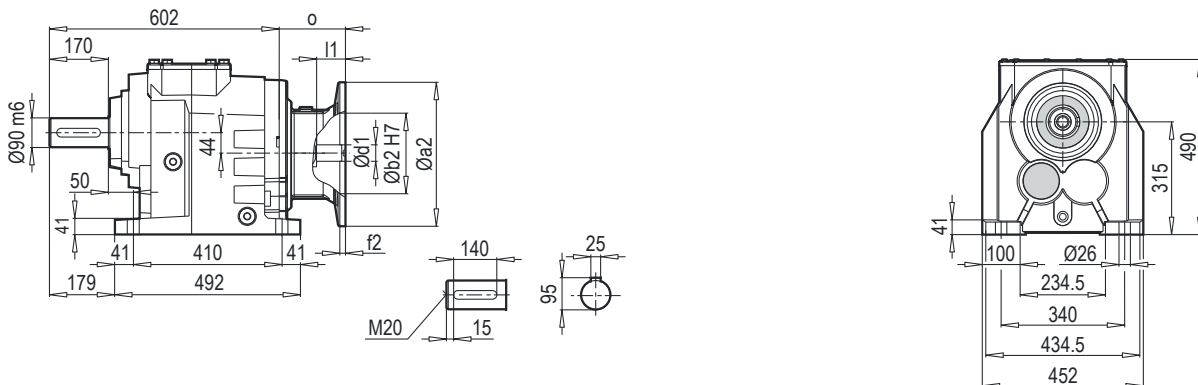

FB

FC

	132	160	180	200	225			
a2	300	350	350	400	450			
b2	230	250	250	300	350			
d1	38	42	48	55	60			
f2	5.5	7	7	7	7			
L	82	112	112	112	142			
u1	10	12	14	16	18			
t1	41.3	45.3	51.8	59.3	64.4			
o	76	124	124	161	161			

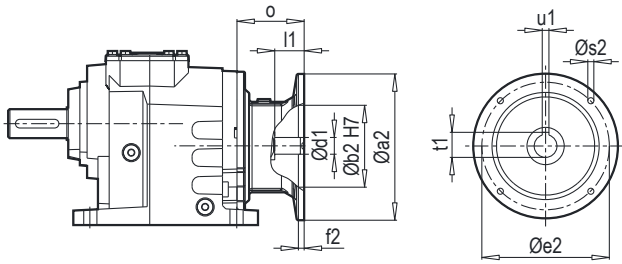
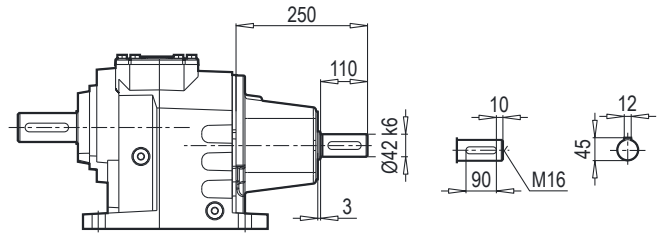
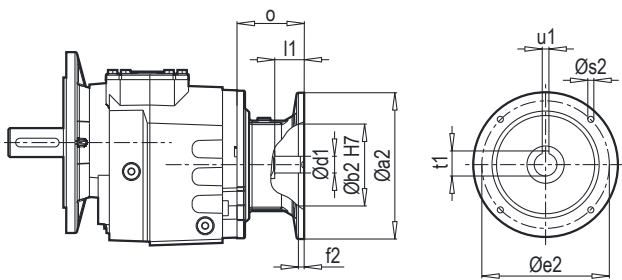
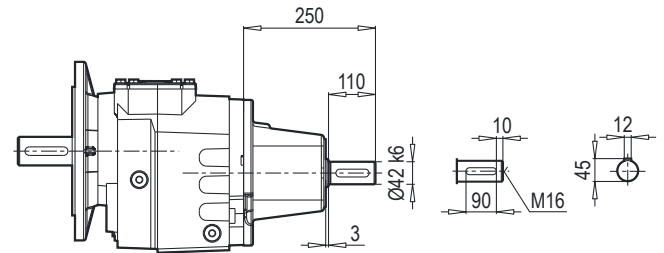
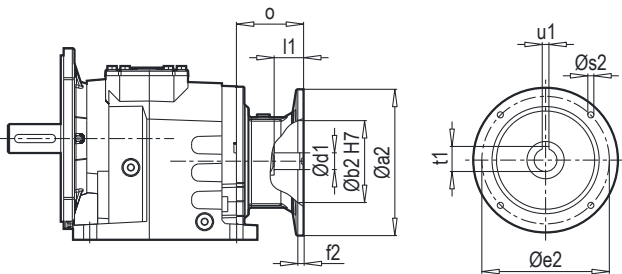
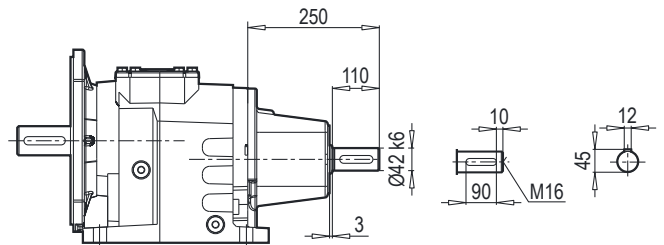
A 902-903 PAM B5/B14

A 902-903 W

F 902-903 PAM B5/B14

F 902-903 W

AF 902-903 PAM B5/B14

AF 902-903 W

W ~ $\frac{Kr}{kr}$	
A/F 902-903	195

Редуктор	PAM B5	Øa2	Øb2	Øe2	f2	Øs2	Ød1	l1	t1	u1	o
A/F 902 A/F 903	132	300	230	265	5.5	M12	38	82	41.3	10	76
	160	350	250	300	7	M16	42	112	45.3	12	124
	180	350	250	300	7	M16	48	112	51.8	14	124
	200	400	300	350	7	M16	55	112	59.3	16	161
	225	450	350	400	7	M16	60	142	64.4	18	161

~ $\frac{Kr}{kr}$	
PAM B5	A/F 902-903
132	182
160	190
180	190
200	205
225	208

Редуктор	PAM B14	Øa2	Øb2	Øe2	f2	Øs2	Ød1	l1	t1	u1	o
A/F 903	132	200	130	165	3.5	11	38	82	41.3	10	76

~ $\frac{Kr}{kr}$	
PAM B14	A/F 903
132	175

Таблицы подбора моторных фланцев IEC и PAM

A 253 → Тип редуктора
F 253

Сервис-фактор выбирается из таблиц подбора мотор-редуктора, т.к. его значение одинаково как для редуктора, так и для редуктора с моторным фланцем PAM-IEC.

Страница каталога с таблицами выбора сервис-фактора

Редуктор	i	4-пол 50Гц 1400об./мин n2 [мин-1]	M _{макс} f _B =1 4 - пол. [Нм]	P _{1макс} W f _B ≥ 1			PAM - IEC							
				4 - пол. 1400об./мин. [кВт]	FR1 [кН]	FR2 [кН]	f _B → 6 - 72							
A253 F253	245.76	5.7	200	0.12	1.4	5.5	63	71						
	197.21	7.1	200	0.15	1.4	5.5	63	71						
	178.56	7.8	200	0.16	1.4	5.5	63	71						
	143.29	9.8	200	0.20	1.4	5.5	63	71						
	123.58	11.3	200	0.24	1.3	5.5	63	71	80	90				
	108.02	13.0	200	0.27	1.3	5.5	63	71						
	100.12	14.0	200	0.29	1.3	5.5	63	71	80	90				
	74.76	18.7	200	0.39	1.3	5.5	63	71	80	90				
	66.56	21.0	200	0.44	1.3	5.5	63	71	80	90				
	53.41	26.2	200	0.55	1.3	5.5	63	71	80					

Передаточное число

Скорость на выходном валу

Крутящий момент на выходе

Значения максимальной мощности при сервис-факторе равном 1: P_{1макс} и f_B = 1

Максимально допустимая радиальная нагрузка на выходном валу

Максимально допустимая радиальная нагрузка на входном валу

Возможные моторные фланцы, применимые с данным типом редуктора и данным передаточным числом (размеры двигателя IEC в соответствии с DIN 50347)

Редуктор	i	4-пол 50Гц 1400об./мин n2 [мин-1]	M _{амакс} f _{B=1} 4 - пол. [Нм]	P _{1макс} W f _B ≥ 1			PAM - IEC								
				4 - пол. 1400об./мин. [кВт]	FR1 [кН]	FR2 [кН]	f _B → 6 - 72								
A202 F202 W 74 + PAM - IEC 74	63.59	22.0	50	0.12	-	2.5	56	63	71						
	55.03	25.4	50	0.13	-	2.5	56	63	71						
	49.05	28.5	46	0.14	-	2.5	56	63	71						
	42.20	33.2	50	0.17	-	2.5	56	63	71						
	36.45	38.4	54	0.22	-	2.5	56	63	71						
	32.41	43.2	55	0.25	-	2.5	56	63	71						
	27.75	50.5	54	0.29	-	2.5	56	63	71						
	24.78	56.5	55	0.33	-	2.5	56	63	71						
	22.26	62.9	55	0.36	-	2.5	56	63	71						
	21.36	65.5	55	0.38	-	2.5	56	63	71						
	19.23	72.8	55	0.42	-	2.5	56	63	71						
	17.37	80.6	55	0.46	-	2.5	56	63	71						
	15.75	88.9	55	0.51	-	2.5	56	63	71						
	14.42	97.1	51	0.52	-	2.5	56	63	71						
	13.23	105.8	47	0.52	-	2.5	56	63	71						
	11.52	121.5	50	0.55	-	2.5	56	63	71						
	10.03	139.6	55	0.55	-	2.5	56	63	71						
	8.93	156.8	55	0.55	-	2.5	56	63	71						
	8.03	174.3	55	0.55	-	2.5	56	63	71						
	7.21	194.2	55	0.55	-	2.5	56	63	71						
	6.55	213.7	53	0.55	-	2.5	56	63	71						
	5.98	234.1	55	0.55	-	2.5	56	63	71						
	5.49	255.0	55	0.55	-	2.5	56	63	71						
	5.33	262.7	55	0.55	-	2.5	56	63	71						
	4.79	292.3	53	0.55	-	2.5	56	63	71						
	4.29	326.3	50	0.55	-	2.5	56	63	71						
	3.90	359.0	45	0.55	-	2.5	56	63	71						
	3.56	393.3	48	0.55	-	2.5	56	63	71						
	3.26	429.4	47	0.55	-	2.5	56	63	71						
	2.97	471.4	46	0.55	-	2.5	56	63	71						
2.83	494.7	45	0.55	-	2.5	56	63	71							
2.55	549.0	41	0.55	-	2.5	56	63	71							
2.31	606.1	39	0.55	-	2.5	56	63	71							
2.12	660.4	36	0.55	-	2.5	56	63	71							

Редуктор	i	4-пол 50Гц 1400об./мин n2 [мин-1]	M _{амакс} f _{B=1} 4 - пол. [Нм]	P _{1макс} W f _B ≥ 1			PAM - IEC																				
				4 - пол. 1400об./мин. [кВт]	FR1 [кН]	FR2 [кН]	f _B → 6 - 72																				
A 202 G F 202 G W 76 + PAM - IEC 76	81.41	17.2	83	0.15	1.2	2.8	56	63	71	80	90																
	70.05	20.0	72	0.15	1.2	2.8	56	63	71	80	90																
	62.38	22.4	64	0.15	1.2	2.8	56	63	71	80	90																
	54.05	25.9	85	0.23	1.2	2.8	56	63	71	80	90																
	46.41	30.2	85	0.27	1.2	2.8	56	63	71	80	90																
	41.38	33.8	85	0.30	1.2	2.8	56	63	71	80	90																
	38.72	36.2	85	0.32	1.2	2.8	56	63	71	80	90																
	34.55	40.5	86	0.36	1.2	2.8	56	63	71	80	90																
	31.03	45.1	92	0.43	1.2	2.8	56	63	71	80	90																
	27.66	50.6	92	0.49	1.2	2.8	56	63	71	80	90																
	24.83	56.4	92	0.54	1.2	2.8	56	63	71	80	90																
	22.44	62.4	92	0.60	1.2	2.8	56	63	71	80	90																
	20.35	68.8	85	0.61	1.2	2.8	56	63	71	80	90																
	18.63	75.1	84	0.66	1.2	2.8	56	63	71	80	90																
	15.74	88.9	85	0.79	1.2	2.8	56	63	71	80	90																
	13.56	103.2	85	0.92	1.2	2.8	56	63	71	80	90																
	12.09	115.8	87	1.05	1.2	2.8	56	63	71	80	90																
	11.41	122.7	85	1.09	1.2	2.8	56	63	71	80	90																
	10.85	129.0	86	1.16	1.2	2.8	56	63	71	80	90																
	9.81	142.7	85	1.27	1.2	2.8	56	63	71	80	90																
	8.75	160.0	88	1.47	1.2	2.8	56	63	71	80	90																
	7.81	179.3	82	1.50	1.2	2.8	56	63	71	80	90																
	7.04	198.9	82	1.50	1.2	2.8	56	63	71	80	90																
	6.41	218.4	82	1.50	1.2	2.8	56	63	71	80	90																
	5.74	243.9	77	1.50	1.2	2.8	56	63	71	80	90																
	5.16	271.3	83	1.50	1.2	2.8	56	63	71	80	90																
4.63	302.4	72	1.50	1.2	2.8	56	63	71	80	90																	
4.19	334.1	65	1.50	1.2	2.8	56	63	71	80	90																	
3.81	367.5	59	1.50	1.2	2.8	56	63	71	80	90																	
3.44	407.0	54	1.50	1.2	2.8	56	63	71	80	90																	
3.24	432.1	54	1.50	1.2	2.8	56	63	71	80	90																	
2.95	474.6	50	1.50	1.2	2.8	56	63	71	80	90																	
2.74	510.9	46	1.50	1.2	2.8	56	63	71	80	90																	
2.51	557.8	43	1.50	1.2	2.8	56	63	71	80	90																	
2.31	606.1	43	1.50	1.2	2.8	56	63	71	80	90																	

Редуктор	i	4-пол 50Гц 1400об./мин n2 [мин-1]	M _{амакс} f _{B=1} 4 - пол. [Нм]	P _{1макс} W f _B ≥ 1			PAM - IEC							
				4 - пол. 1400об./мин. [кВт]	FR1 [кН]	FR2 [кН]	f _B → 6 - 72							
A253 F253 W 78 + PAM - IEC 78	245.76	5.7	200	0.12	1.4	5.5	63	71						
	197.21	7.1	200	0.15	1.4	5.5	63	71						
	178.56	7.8	200	0.16	1.4	5.5	63	71						
	143.29	9.8	200	0.20	1.4	5.5	63	71						
	123.58	11.3	200	0.24	1.3	5.5	63	71	80	90				
	108.02	13.0	200	0.27	1.3	5.5	63	71						
	99.17	14.1	200	0.30	1.3	5.5	63	71	80	90				
	74.76	18.7	200	0.39	1.3	5.5	63	71	80	90				
	66.56	21.0	200	0.44	1.3	5.5	63	71	80	90				
	53.41	26.2	200	0.55	1.3	5.5	63	71	80	90				
A252 F252 W 78 + PAM - IEC 78	47.93	29.2	200	0.61	1.3	5.5	71	80	90					
	42.00	33.3	200	0.70	1.2	5.5	71	80	90					
	38.46	36.4	200	0.76	1.2	5.5	71	80	90					
	33.38	41.9	200	0.88	1.2	5.5	71	80	90					
	30.15	46.4	200	0.97	1.2	5.3	71	80	90					
	26.79	52.3	200	1.09	1.1	5.0	71	80	90					
	24.19	57.9	200	1.21	1.1	4.8	71	80	90					
	23.04	60.8	200	1.27	1.1	4.7	71	80	90	100	112			
	20.19	69.3	200	1.45	1.1	4.4	71	80	90					
	18.49	75.7	200	1.59	1.0	4.2	71	80	90	100	112			
	17.05	82.1	190	1.63	1.0	4.1	71	80	90	100	112			
	14.91	93.9	170	1.67	1.0	4.1	71	80	90	100	112			
	13.94	100.4	170	1.79	1.0	3.9	71	80	90	100	112			
	11.97	117.0	145	1.78	1.0	3.9	71	80	90	100	112			
	10.32	135.7	140	1.99	0.9	3.7	71	80	90	100	112			
	9.02	155.2	130	2.11	0.9	3.6	71	80	90	100	112			
	7.93	176.5	125	2.31	0.8	3.4	71	80	90	100	112			
	6.36	220.0	105	2.42	0.8	3.3	71	80	90	100	112			
	4.80	291.8	95	2.90	0.7	3.0	71	80	90	100	112			

Редуктор	i	4-пол 50Гц 1400об./мин n2 [мин-1]	M _{макс} f _B =1 4 - пол. [Нм]	P _{1макс} W f _B ≥ 1			PAM - IEC										
				4 - пол. 1400об./мин. [кВт]	FR1 [кН]	FR2 [кН]	f _B → 6 - 72										
A303 F303 W 82 + PAM - IEC 82	282.17	5.0	300	0.16	1.4	6.6	63	71									
	227.56	6.2	300	0.19	1.4	6.6	63	71									
	205.01	6.8	300	0.21	1.4	6.6	63	71									
	165.33	8.5	300	0.27	1.4	6.6	63	71									
	141.89	9.9	300	0.31	1.4	6.6	63	71	80	90							
	125.65	11.1	300	0.35	1.3	6.6	63	71									
	114.42	12.2	300	0.38	1.3	6.6	63	71	80	90							
	86.96	16.1	300	0.51	1.3	6.6	63	71	80	90							
	76.42	18.3	300	0.58	1.3	6.6	63	71	80	90							
	61.63	22.7	300	0.71	1.3	6.6	63	71	80	90							
A302 F302 W 82 + PAM - IEC 82	55.03	25.4	280	0.75	1.3	6.6	71	80	90								
	48.22	29.0	280	0.85	1.2	6.6	71	80	90								
	44.38	31.5	280	0.93	1.2	6.6	71	80	90								
	38.33	36.5	280	1.07	1.2	6.6	71	80	90								
	34.62	40.4	280	1.19	1.2	6.6	71	80	90								
	30.91	45.3	280	1.33	1.1	6.6	71	80	90								
	27.92	50.1	280	1.47	1.1	6.6	71	80	90								
	26.45	52.9	260	1.44	1.1	6.6	71	80	90	100	112						
	23.49	59.6	260	1.62	1.0	6.3	71	80	90								
	21.33	65.6	250	1.72	1.0	6.1	71	80	90	100	112						
	19.29	72.6	250	1.90	1.0	5.8	71	80	90	100	112						
	16.21	86.3	250	2.26	0.9	5.4	71	80	90	100	112						
	13.81	101.4	250	2.65	0.8	5.0	71	80	90	100	112						
	12.00	116.7	250	3.05	0.7	4.7	71	80	90	100	112						
	10.50	133.4	240	3.35	0.6	4.5	71	80	90	100	112						
9.11	153.7	210	3.38	0.6	4.4	71	80	90	100	112							
7.34	190.6	160	3.19	0.7	4.4	71	80	90	100	112							
5.58	250.8	160	4.20	0.4	3.9	71	80	90	100	112							
A301 F301 W 80 + PAM - IEC 80	8.88	157.7	55	0.91	1.2	1.0	71	80	90								
	7.78	180.0	50	0.94	1.2	1.0	71	80	90								
	6.18	226.5	50	1.19	1.2	0.9	71	80	90								
	5.58	250.7	50	1.31	1.2	0.9	71	80	90								
	5.08	275.8	45	1.30	1.2	0.9	71	80	90								
	4.27	328.1	45	1.55	1.1	0.8	71	80	90								
	3.65	383.9	45	1.81	1.1	0.8	71	80	90								
	3.16	443.3	40	1.86	1.1	0.7	71	80	90								
	2.76	506.9	30	1.59	1.1	0.7	71	80	90								
	2.59	540.4	30	1.70	1.1	0.7	71	80	90								
2.04	686.8	25	1.80	1.1	0.7	71	80	90									
1.47	953.2	25	2.50	1.0	0.6	71	80	90									









Редуктор	i	4-пол 50Гц 1400об./мин n2 [мин-1]	M _{амакс} f _B =1 4 - пол. [Нм]	P _{1макс} W f _B ≥ 1			PAM - IEC											
				4 - пол. 1400об./мин. [кВт]	FR1 [кН]	FR2 [кН]	f _B → 6 - 72											
A353 F353 W 86 + PAM - IEC 86	268.00	5.2	500	0.27	1.4	8.0	63	71										
	216.67	6.5	500	0.34	1.3	8.0	63	71										
	194.72	7.2	500	0.38	1.3	8.0	63	71										
	86	157.42	8.9	500	0.47	1.3	8.0	63	71									
		134.76	10.4	500	0.54	1.3	8.0	63	71	80	90							
	+ PAM - IEC	108.95	12.9	500	0.67	1.3	8.0	63	71	80	90							
	86	90.51	15.5	500	0.81	1.3	8.0	63	71	80	90							
		72.58	19.3	500	1.01	1.2	8.0	63	71	80	90							
		58.68	23.9	500	1.25	1.2	8.0	63	71	80	90							
A352 F352 W 86 + PAM - IEC 86	56.95	24.6	490	1.26	1.2	8.0	71	80	90									
	49.88	28.1	490	1.44	1.1	8.0	71	80	90									
	46.04	30.4	490	1.56	1.1	8.0	71	80	90									
	86	39.59	35.4	490	1.81	1.1	8.0	71	80	90	100	112						
		33.50	41.8	490	2.14	1.0	8.0	71	80	90								
	+ PAM - IEC	32.01	43.7	490	2.24	1.0	8.0	71	80	90	100	112						
	86	28.89	48.5	490	2.49	1.0	7.9	71	80	90	100	112						
		26.59	52.6	490	2.70	0.9	7.6	71	80	90	100	112						
		25.13	55.7	470	2.74	0.9	7.5	71	80	90	100	112						
		22.03	63.6	470	3.13	0.9	7.1	71	80	90	100	112						
		20.31	68.9	460	3.32	0.8	6.9	71	80	90	100	112						
		18.30	76.5	460	3.68	0.8	6.5	71	80	90	100	112						
		16.88	83.0	450	3.91	0.7	6.3	71	80	90	100	112						
		14.52	96.4	430	4.34	0.6	6.0		80	90	100	112						
		11.74	119.3	390	4.87	0.6	5.7		80	90	100	112						
		9.75	143.6	370	5.56	0.4	5.3		80	90	100	112						
		8.73	160.4	340	5.71	0.4	5.2		80	90	100	112						
	7.06	198.4	290	6.02	0.3	5.1		80	90	100	112							
	5.86	238.8	260	6.50	0.3	4.8		80	90	100	112							
A351 F351 W 84 + PAM - IEC 84	8.50	164.7	100	1.72	1.2	2.5	71	80	90									
	7.44	188.1	100	1.97	1.1	2.5	71	80	90									
	5.91	236.9	100	2.48	1.1	2.3	71	80	90	100	112							
	84	5.33	262.5	100	2.75	1.0	2.2	71	80	90	100	112						
		4.85	288.9	95	2.87	1.0	2.2	71	80	90	100	112						
	+ PAM - IEC	4.07	344.3	90	3.24	1.0	2.0	71	80	90	100	112						
	84	3.75	373.3	90	3.52	1.0	2.0	71	80	90	100	112						
		3.22	434.5	80	3.64	0.9	1.9	71	80	90	100	112						
		2.62	534.5	70	3.92	0.9	1.8	71	80	90	100	112						
	2.17	646.2	60	4.06	0.9	1.7		80	90	100	112							
	1.45	964.4	60	6.06	0.6	1.5		80	90	100	112							
	1.30	1074.4	40	4.50	0.8	1.5		80	90	100	112							

Редуктор	i	4-пол 50Гц 1400об./мин n2 [мин-1]	M _{амакс} f _B =1 4 - пол. [Нм]	P _{1макс} W f _B ≥ 1			PAM - IEC								
				4 - пол. 1400об./мин. [кВт]	FR1 [кН]	FR2 [кН]	f _B → 6 - 72								
A403 F403 W 90 + PAM - IEC 90	267.75	5.2	850	0.47	2.8	12.0	71	80	90						
	234.50	6.0	850	0.53	2.8	12.0	71	80	90						
	215.01	6.5	850	0.58	2.8	12.0	71	80	90						
	186.14	7.5	850	0.67	2.7	12.0	71	80	90	100	112				
	170.55	8.2	850	0.73	2.7	12.0	71	80	90						
	149.47	9.4	850	0.83	2.7	12.0	71	80	90	100	112				
	135.37	10.3	850	0.92	2.7	12.0	71	80	90	100	112				
	118.13	11.9	850	1.05	2.7	12.0	71	80	90	100	112				
	94.86	14.8	850	1.31	2.7	12.0	71	80	90	100	112				
	85.91	16.3	850	1.45	2.6	12.0	71	80	90	100	112				
	68.25	20.5	850	1.83	2.6	12.0		80	90	100	112				
	54.81	25.5	850	2.27	2.5	12.0		80	90	100	112				
	49.64	28.2	850	2.51	2.5	12.0		80	90	100	112				
	A402 F402 W 90 + PAM - IEC 90	45.38	30.9	850	2.75	2.4	12.0	80	90	100	112				
39.72		35.2	850	3.14	2.4	12.0	80	90	100	112					
36.44		38.4	800	3.22	2.4	12.0	80	90	100	112					
31.50		44.4	850	3.96	2.3	12.0	80	90	100	112	132				
28.89		48.5	800	4.06	2.3	12.0	80	90	100	112					
25.30		55.3	850	4.93	2.1	12.0	80	90	100	112	132				
22.91		61.1	850	5.44	2.1	12.0	80	90	100	112	132				
19.94		70.2	850	6.25	1.9	11.7	80	90	100	112	132				
17.37		80.6	830	7.00	1.8	11.1	80	90	100	112	132				
16.01		87.4	800	7.33	1.8	10.8	80	90	100	112	132				
14.50		96.6	700	7.08	1.8	10.9	80	90	100	112	132				
12.44		112.5	700	8.25	1.7	10.2	80	90	100	112	132				
11.46		122.2	650	8.32	1.7	10.1	80	90	100	112	132				
9.20		152.2	600	9.56	1.5	9.4	80	90	100	112	132				
8.33		168.0	600	10.55	1.3	9.0	80	90	100	112	132				
7.22		193.9	550	11.17	1.3	8.7	80	90	100	112	132				
5.80	241.5	550	13.91	0.9	7.9	80	90	100	112	132					
5.25	266.7	500	13.96	0.9	7.8	80	90	100	112	132					
A401 F401 W 88 + PAM - IEC 88	8.25	169.7	170	3.02	2.7	3.7	80	90	100	112					
	7.22	193.8	170	3.45	2.6	3.7	80	90	100	112					
	5.73	244.4	170	4.35	2.5	3.4	80	90	100	112					
	5.17	271.0	170	4.82	2.5	3.2	80	90	100	112					
	4.69	298.4	160	5.00	2.5	3.1	80	90	100	112					
	3.93	355.9	150	5.59	2.4	3.0	80	90	100	112					
	3.63	386.2	150	6.07	2.4	2.9	80	90	100	112					
	3.11	450.0	130	6.13	2.4	2.8	80	90	100	112					
	2.52	554.7	120	6.97	2.3	2.6	80	90	100	112					
	2.08	672.0	120	8.44	2.1	2.4	80	90	100	112					
1.31	1066.7	80	8.94	2.1	2.2	80	90	100	112						

Редуктор	i	4-пол 50Гц 1400об./мин n2 [мин-1]	M _{макс} f _B =1 4 - пол. [Нм]	P _{1макс} W f _B ≥ 1			PAM - IEC								
				4 - пол. 1400об./мин. [кВт]	FR1 [кН]	FR2 [кН]	f _B → 6 - 72								
A503 F503 W 94 + PAM - IEC 94	222.59	6.3	1800	1.19	2.9	18.0	80	90	90						
	194.86	7.2	1800	1.35	2.9	18.0	80	90	90						
	178.98	7.8	1800	1.47	2.8	18.0	80	90	90						
	162.21	8.6	1800	1.63	2.8	18.0	80	90	90						
	154.52	9.1	1800	1.71	2.8	18.0	80	90	90	100	112	132			
	142.00	9.9	1800	1.86	2.8	18.0	80	90	90	100	112				
	124.25	11.3	1800	2.12	2.8	18.0	80	90	90	100	112	132			
	112.61	12.4	1800	2.34	2.7	18.0	80	90	90	100	112	132			
	97.80	14.3	1800	2.70	2.7	18.0	80	90	90	100	112	132			
	85.33	16.4	1800	3.09	2.7	18.0	80	90	90	100	112	132			
	78.64	17.8	1800	3.36	2.6	18.0	80	90	90	100	112	132			
	71.27	19.6	1800	3.70	2.6	18.0	80	90	90	100	112	132			
	56.21	24.9	1600	4.17	2.5	18.0	80	90	90	100	112	132			
	A502 F502 W 94 + PAM - IEC 94	48.77	28.7	1600	4.81	2.4	18.0	80	90	100	112	132			
43.32		32.3	1600	5.41	2.4	18.0	80	90	100	112	132				
39.21		35.7	1600	5.98	2.3	17.7	80	90	100	112	132				
34.83		40.2	1600	6.73	2.2	16.7	80	90	100	112	132				
31.57		44.3	1600	7.43	2.1	16.0	80	90	100	112	132				
28.26		49.5	1600	8.30	2.0	15.1	80	90	100	112	132				
26.98		51.9	1600	8.69	2.0	14.8			100	112	132	160			
23.14		60.5	1600	10.14	1.8	13.7			100	112	132	160			
21.69		64.5	1600	10.81	1.7	13.2			100	112	132	160			
19.66		71.2	1600	11.93	1.6	12.6			100	112	132	160			
18.81		74.4	1500	11.69	1.6	12.7			100	112	132	160			
16.86		83.0	1500	13.04	1.5	12.1			100	112	132	160			
15.13		92.6	1500	14.54	1.3	11.4			100	112	132	160			
13.71		102.1	1400	14.97	1.3	11.3			100	112	132	160			
11.20		125.0	1100	14.39	1.3	11.5					132	160			
9.01		155.4	900	14.65	1.3	11.2					132	160			
8.16		171.5	800	14.36	1.3	11.2					132	160			
7.55	185.5	800	15.54	1.2	10.8					132	160				
6.07	230.6	700	16.91	1.0	10.3					132	160				
5.50	254.5	700	18.65	0.8	9.8					132	160				
A501 F501 W 92 + PAM - IEC 92	8.56	163.6	350	6.00	2.5	4.0	80	90	100	112	132				
	7.60	184.2	350	6.75	2.4	4.0	80	90	100	112	132				
	6.17	227.0	340	8.08	2.3	3.9	80	90	100	112	132				
	5.62	249.3	330	8.62	2.2	3.7	80	90	100	112	132				
	4.73	295.8	320	9.91	2.1	3.5			100	112	132				
	4.06	344.9	320	11.56	1.9	3.3			100	112	132				
	3.78	370.6	310	12.03	1.9	3.2			100	112	132				
	3.30	424.2	310	13.77	1.7	3.0			100	112	132				
	2.58	541.9	280	15.89	1.5	2.8			100	112	132				
	1.97	712.3	230	17.15	1.4	2.7					132				
1.46	960.8	220	22.13	0.9	2.4					132					
1.32	1057.1	200	22.14	0.9	2.3					132					

Редуктор	i	4-пол 50Гц 1400об./мин n2 [мин-1]	M _{амакс} f _B =1 4 - пол. [Нм]	P _{1макс} W f _B ≥ 1			PAM - IEC								
				4 - пол. 1400об./мин. [кВт]	FR1 [кН]	FR2 [кН]	f _B → 6 - 72								
A603 F603 W 98 + PAM - IEC 98	242.67	5.8	3600	2.17	4.0	22.0	90	100	112	132					
	215.56	6.5	3500	2.38	4.0	22.0	90	100	112	132					
	194.31	7.2	3500	2.64	4.0	22.0	90	100	112	132					
	181.13	7.7	3500	2.83	4.0	22.0	90	100	112	132					
	160.90	8.7	3500	3.19	3.9	22.0	90	100	112	132					
	143.57	9.8	3500	3.57	3.9	22.0	90	100	112	132					
	134.25	10.4	3500	3.82	3.9	22.0		100	112	132	160				
	121.02	11.6	3500	4.24	3.9	22.0		100	112	132	160				
	100.21	14.0	3500	5.12	3.9	22.0		100	112	132	160				
	93.60	15.0	3500	5.48	3.8	22.0		100	112	132	160				
	84.37	16.6	3500	6.08	3.8	22.0		100	112	132	160				
	79.98	17.5	3500	6.42	3.8	22.0		100	112	132	160				
	69.87	20.0	3500	7.34	3.7	22.0		100	112	132	160				
	55.75	25.1	3500	9.20	3.7	22.0				132	160				
	A602 F602 W 98 + PAM - IEC 98	50.91	27.5	3300	9.50	3.6	22.0	100	112	132					
45.27		30.9	3300	10.69	3.6	22.0	100	112	132	160					
40.81		34.3	3300	11.85	3.5	21.7	100	112	132	160					
38.00		36.8	2800	10.80	3.6	22.0	100	112	132						
33.79		41.4	3200	13.88	3.4	20.0	100	112	132	160					
30.35		46.1	3200	15.46	3.4	18.9	100	112	132	160					
28.36		49.4	3300	17.06	3.3	17.8	100	112	132	160	180				
25.57		54.8	3300	18.92	3.2	16.8	100	112	132	160	180				
23.66		59.2	3300	20.45	3.1	16.1	100	112	132	160	180				
21.17		66.1	3200	22.16	3.1	15.4	100	112	132	160	180				
19.59		71.5	3200	23.94	3.0	14.7	100	112	132	160	180				
17.60		79.5	3200	26.65	2.9	13.8	100	112	132	160	180				
15.87		88.2	3200	29.56	2.7	12.9	100	112	132	160	180				
13.14		106.5	3100	34.59	2.5	11.8	100	112	132	160	180				
10.91		128.3	3000	40.31	2.2	10.8				132	160	180			
9.83		142.4	2800	41.74	2.2	10.8				132	160	180			
8.14		171.9	2500	45.01	2.0	10.6				132	160	180			
6.92	202.4	2300	48.74	1.8	10.4				132	160	180				
6.24	224.5	2000	47.02	1.9	10.9				132	160	180				
5.16	271.1	1800	51.10	1.7	10.5				132	160	180				
A601 F601 W 96 + PAM - IEC 96	8.30	168.7	650	11.48	3.4	5.0	100	112	132	160					
	7.45	187.8	650	12.78	3.4	5.0	100	112	132	160					
	6.15	227.5	640	15.25	3.3	4.9	100	112	132	160					
	5.20	269.2	620	17.48	3.1	4.6	100	112	132	160	180				
	4.81	290.9	620	18.89	3.1	4.4	100	112	132	160	180				
	4.28	327.3	610	20.90	3.0	4.2				132	160	180			
	3.65	383.6	600	24.10	2.8	3.9	100	112	132	160	180				
	3.23	433.8	600	27.25	2.7	3.7	100	112	132	160	180				
	2.44	572.7	550	32.98	2.4	3.4				132	160	180			
	2.00	700.0	450	32.98	2.4	3.3				132	160	180			
1.38	1011.1	450	47.64	1.7	2.8				132	160	180				
1.27	1103.8	400	46.23	1.8	2.8				132	160	180				

Редуктор	i	4-пол 50Гц 1400об./мин n2 [мин-1]	M _{амакс} f _{B=1} 4 - пол. [Нм]	P _{1макс} W f _B ≥ 1			PAM - IEC									
				4 - пол. 1400об./мин. [кВт]	FR1 [кН]	FR2 [кН]	f _B → 6 - 72									
A703 F703 W 102 + PAM - IEC 102	260.15	5.4	5000	2.82	3.9	30.0	100	112	132							
	231.34	6.1	5000	3.17	3.9	30.0	100	112	132	160	180					
	207.78	6.7	5000	3.53	3.9	30.0	100	112	132	160	180					
	189.54	7.4	5000	3.87	3.9	30.0	100	112	132	160	180					
	173.11	8.1	5000	4.23	3.9	30.0	100	112	132	160	180					
	155.48	9.0	5000	4.71	3.8	30.0	100	112	132	160	180					
	144.94	9.7	5000	5.06	3.8	30.0	100	112	132	160	180	200				
	128.35	10.9	5000	5.71	3.8	30.0	100	112	132	160	180					
	118.75	11.8	5000	6.17	3.8	30.0	100	112	132	160	180	200				
	108.46	12.9	5000	6.76	3.8	30.0	100	112	132	160	180	200				
	100.38	13.9	5000	7.30	3.7	30.0	100	112	132	160	180	200				
	89.95	15.6	5000	8.15	3.7	30.0	100	112	132	160	180	200				
	83.35	16.8	5000	8.79	3.7	30.0	100	112	132	160	180	200				
	73.70	19.0	5000	9.95	3.6	30.0	100	112	132	160	180	200				
	67.31	20.8	5000	10.89	3.6	30.0	100	112	132	160	180	200				
	55.75	25.1	5000	13.15	3.5	30.0			132	160	180	200				
	45.67	30.7	5000	16.05	3.4	30.0			132	160	180	200				
A702 F702 W 102 + PAM - IEC 102	44.67	31.3	5000	16.41	3.4	30.0	132	160	180							
	36.60	38.3	5000	20.03	3.2	30.0	132	160	180							
	33.43	41.9	5000	21.93	3.2	29.5	132	160	180							
	30.27	46.2	5000	24.21	3.1	28.0	132	160	180							
	27.87	50.2	5000	26.30	3.0	26.8	132	160	180	200						
	24.80	56.4	5000	29.55	2.9	25.2	132	160	180							
	22.84	61.3	5000	32.10	2.8	24.1	132	160	180	200						
	20.86	67.1	5000	35.14	2.6	22.9	132	160	180	200						
	19.60	71.4	5000	37.40	2.6	22.1	132	160	180	200						
	17.18	81.5	4800	40.95	2.4	21.1	132	160	180	200						
	14.08	99.5	4600	47.90	2.1	19.4	132	160	180	200						
	12.86	108.9	4400	50.17	2.0	19.0	132	160	180	200						
	10.53	132.9	4000	55.68	1.8	18.2		160	180	200						
	8.63	162.3	3800	64.57	1.5	16.9		160	180	200						
	7.88	177.7	3700	68.83	1.3	16.3		160	180	200						
	7.20	194.6	3600	73.34	1.1	15.8		160	180	200						
	5.90	237.5	3200	79.57	0.9	15.3		160	180	200						
5.38	260.0	3000	81.68	0.8	15.2		160	180	200							
A701 F701 W 100 + PAM - IEC 100	7.80	179.5	1000	18.79	3.2	6.0	132	160	180							
	6.33	221.1	900	20.83	3.1	6.0	132	160	180							
	5.29	264.9	880	24.41	3.0	5.8	132	160	180							
	4.87	287.7	870	26.21	2.9	5.6	132	160	180	200						
	4.18	335.2	850	29.84	2.7	5.3	132	160	180	200						
	3.63	385.5	850	34.31	2.6	5.0	132	160	180	200						
	3.19	438.8	820	37.68	2.4	4.8	132	160	180	200						
	3.00	466.7	800	39.09	2.4	4.7	132	160	180	200						
	2.52	555.6	800	46.54	2.1	4.3	132	160	180	200						
	2.03	688.1	750	54.04	1.8	4.0	132	160	180	200						
	1.84	761.4	700	55.81	1.7	3.9		160	180	200						
1.44	969.2	700	71.04	1.1	3.5		160	180	200							
1.26	1114.3	650	75.84	0.9	3.4		160	180	200							

Редуктор	i	4-пол 50Гц 1400об./мин n2 [мин-1]	M _{амакс} f _B =1 4 - пол. [Нм]	P _{1макс} W f _B ≥ 1			PAM - IEC									
				4 - пол. 1400об./мин. [кВт]	FR1 [кН]	FR2 [кН]	f _B →  6 - 72									
A903 F903 W   104 + PAM - IEC   104	205.73	6.8	8000	5.70	8.0	55.0	132	160	180							
	185.64	7.5	8000	6.32	8.0	55.0	132	160	180							
	154.07	9.1	8000	7.61	8.0	55.0	132	160	180							
	139.41	10.0	8000	8.41	8.0	55.0	132	160	180							
	128.36	10.9	8000	9.14	8.0	55.0	132	160	180	200						
	115.83	12.1	8000	10.13	8.0	55.0	132	160	180	200						
	104.41	13.4	8000	11.23	8.0	55.0	132	160	180							
	96.13	14.6	8000	12.20	8.0	55.0	132	160	180	200						
	86.43	16.2	8000	13.57	8.0	55.0	132	160	180	200						
	79.13	17.7	8000	14.82	8.0	55.0	132	160	180	200						
	71.40	19.6	8000	16.43	8.0	54.3	132	160	180	200						
	63.02	22.2	8000	18.61	8.0	51.2	132	160	180	200						
	59.26	23.6	8000	19.79	8.0	49.6	132	160	180	200						
	53.66	26.1	8000	21.86	8.0	47.2	132	160	180	200						
	48.50	28.9	8000	24.18	8.0	44.9		160	180	200						
	A902 F902 W   104 + PAM - IEC   104	42.47	33.0	8000	27.61	5.1	42.3	160	180	200	225					
38.33		36.5	8000	30.60	5.1	40.1	160	180	200	225						
31.81		44.0	8000	36.87	5.1	36.3	160	180	200	225						
26.38		53.1	8000	44.46	5.1	32.3	160	180	200	225						
23.80		58.8	8000	49.28	5.1	30.8	160	180	200	225						
19.75		70.9	8000	59.37	5.1	27.5	160	180	200	225						
17.18		81.5	7900	67.42	5.1	25.5	160	180	200	225						
15.50		90.3	7800	73.77	5.1	24.2	160	180	200	225						
12.86		108.8	7300	83.19	5.1	22.9	160	180	200	225						
10.28		136.2	7200	102.69	5.0	20.0	160	180	200	225						
9.28		150.9	6500	102.74	5.0	20.7	160	180	200	225						
7.70		181.9	5300	100.94	5.0	21.9	160	180	200	225						
6.89		203.2	5000	106.38	4.0	21.5	160	180	200	225						
6.22		225.2	4900	115.54	4.0	20.6	160	180	200	225						
5.16		271.3	4600	130.69	4.0	19.4	160	180	200	225						

Компания Редуктор

Г. Нижний Новгород, ул. Зайцева 31, оф. 508

Тел./факс +7 (831) 223-81-81

E-mail: info@reduktor.nnov.ru

Сайт: <http://www.reduktor-innovari.ru/>



A series of horizontal dotted lines spanning the width of the page, intended for writing or drawing.